

PALLETIZING

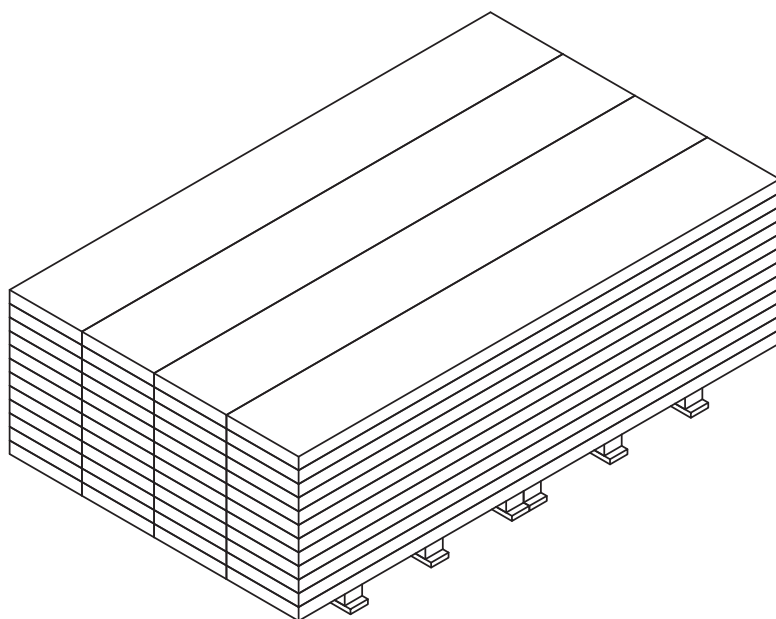

Rev.	Latest Revision / Description						
C	Vægt er opdateret.						
Item number	Component	Pcs.	L	W	T	Gross weight in kg	Net weight in kg
089122y	Palle, TS50, Special.	2	1160	770	129		
Box 1 af 3		48	2070	311	51	13,9	13,2
tvilum	Seng 90x200 Paris		INIT:	BKA	DATE :	15-10-2009	
			REVISION:	C	Approved by:	JR	
77801			DWG.NO.		77801-70		

PALLETIZING

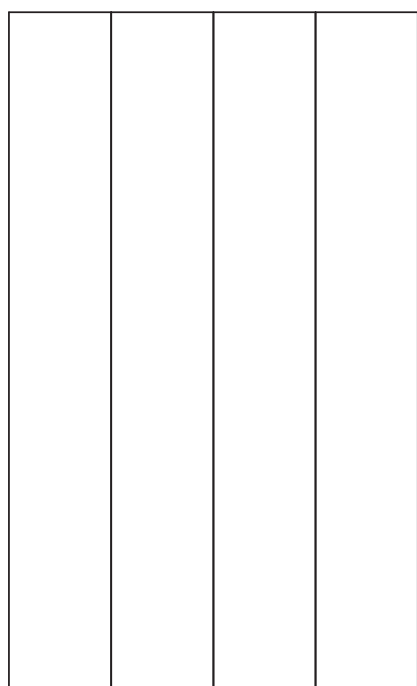
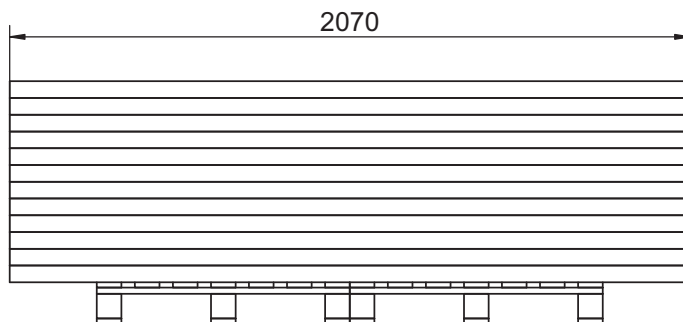
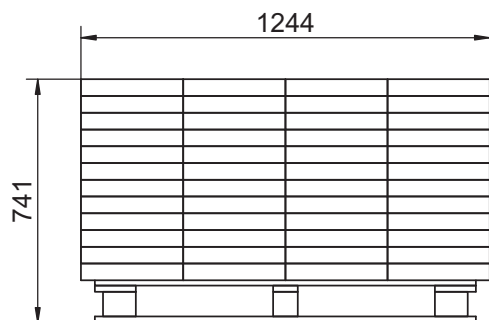
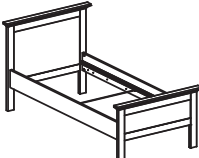
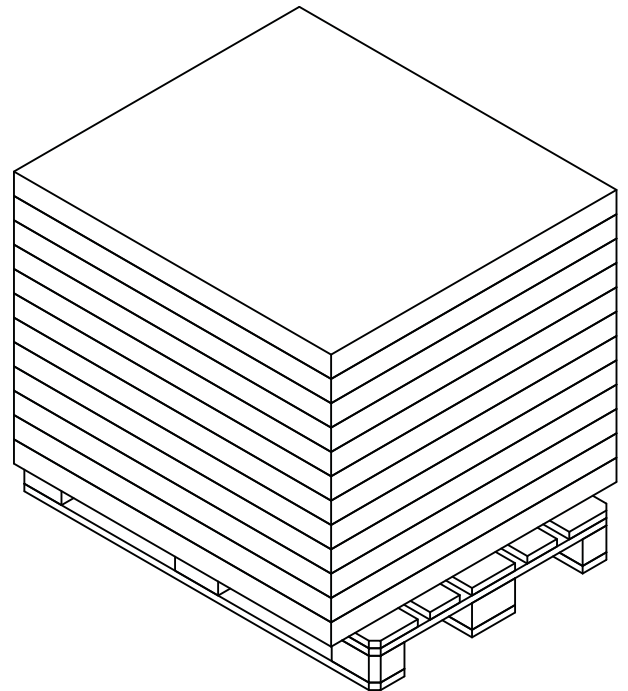
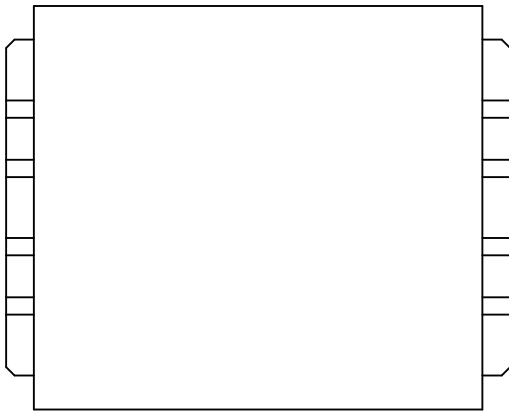
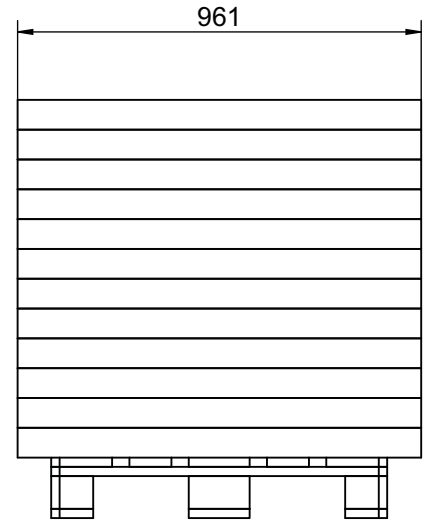
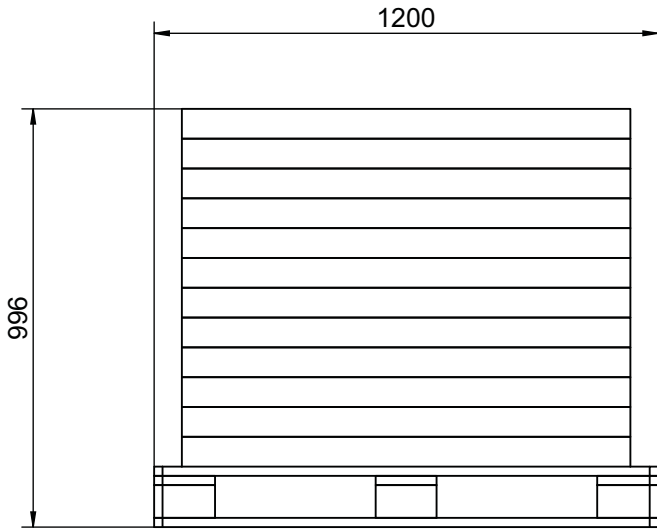

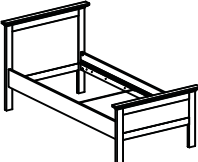
Rev.	Latest Revision / Description						
D	Palle TS50 089122y ændret til EUR-palle 089042Y.						
Item number	Component	Pcs.	L	W	T	Gross weight in kg	Net weight in kg
089042y	Palle, EUR	1	1200	800	144		
Box 2 af 3		12	1068	961	71	18,7	17,2
tvilum	Seng 90x200 Paris		INIT:	BKA	DATE :	15-10-2009	
			REVISION:	D	Approved by:	JR	
77801			DWG.NO.		77801-70		

PALLETIZING

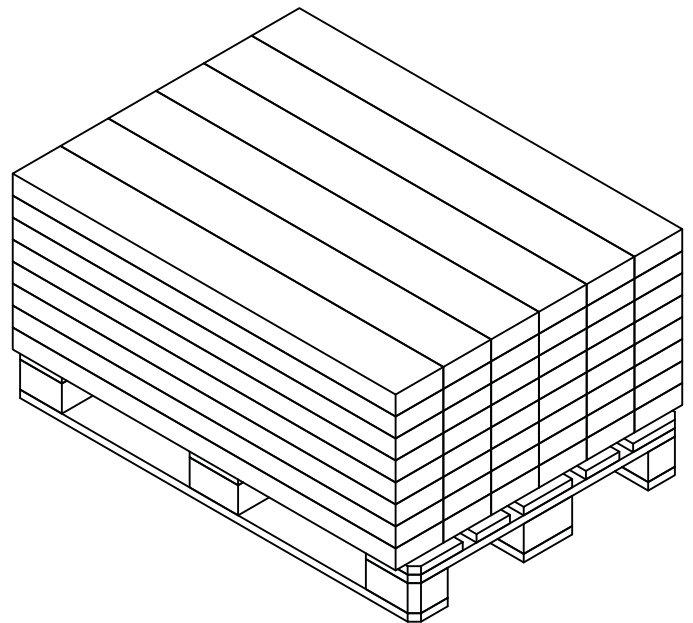
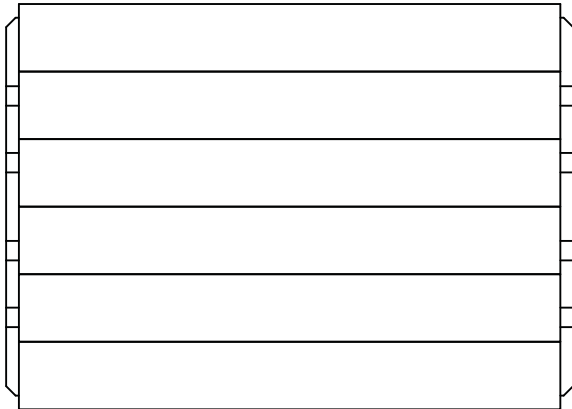
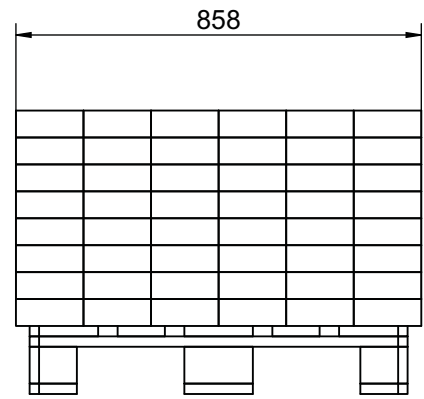
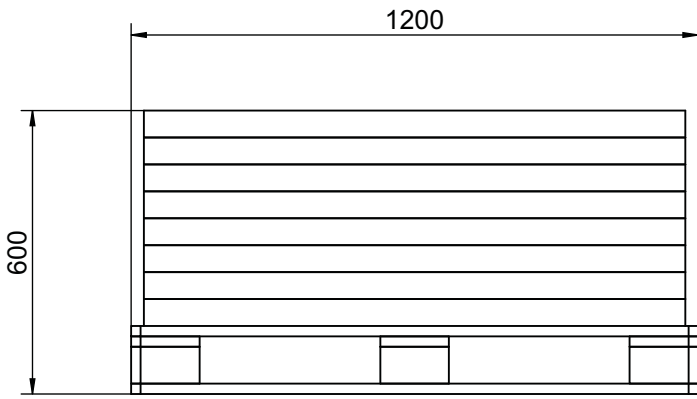

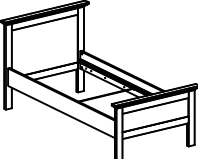
Rev.	Latest Revision / Description						
D	PalleTS50 089122y ændret til EUR-palle 089042y.						
Item number	Component	Pcs.	L	W	T	Gross weight in kg	Net weight in kg
089042y	Palle, EUR	1	1200	800	144		
Box 3 af 3		48	1146	143	57	4,5	4,3
tvilum	Seng 90x200 Paris		INIT:	JR	DATE :	15-10-2009	
			REVISION:	D	Approved by:	JR	
77801			DWG.NO.		77801-70		