

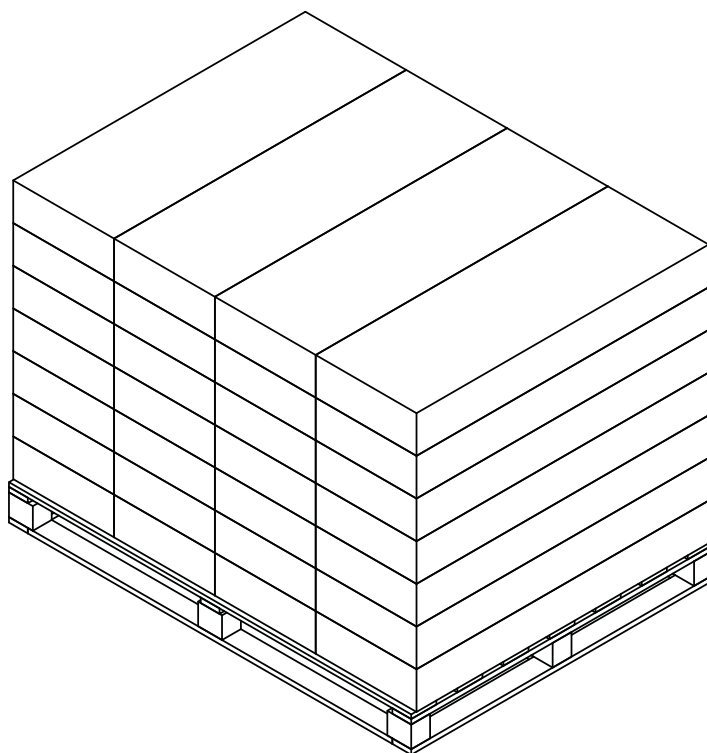

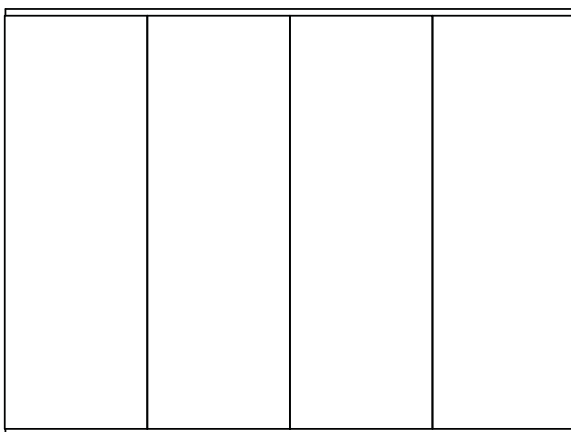

PALLETIZING

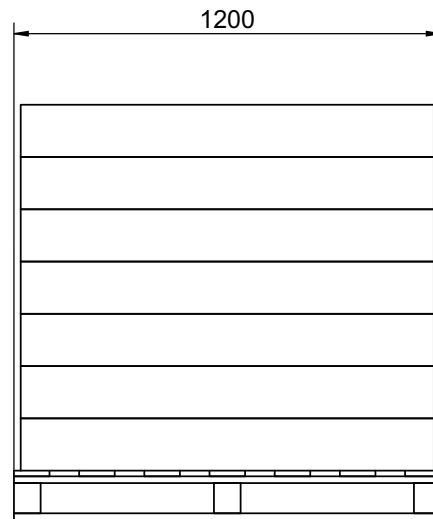
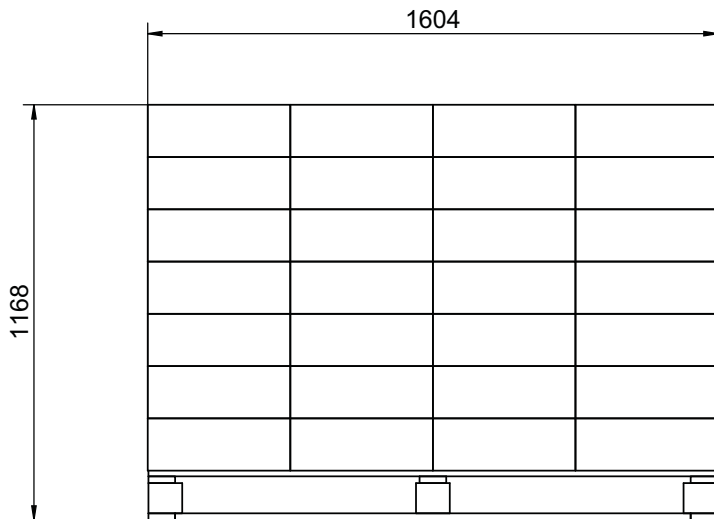

Rev.	Latest Revision / Description						
B	25-05-2020 JR (ECO10739): Udv. mål ændret fra 1162x371x147 til 1162x401x147. Ny palle.						
Item number	Component	Pcs.	L	W	T	Gross weight in kg	Net weight in kg
089113	Palle, TS40, Special.	1	1600	1200	139	20 kg.	
Box 1 of 2		28	1162	401	147	29,6	28,8
tvilum 92176	Vitrine 2 låger Roomers		INIT:	JR	DATE :	16-03-2017	
			REVISION:	B	Approved by:	JR	
			DWG.NO.	92176-70			

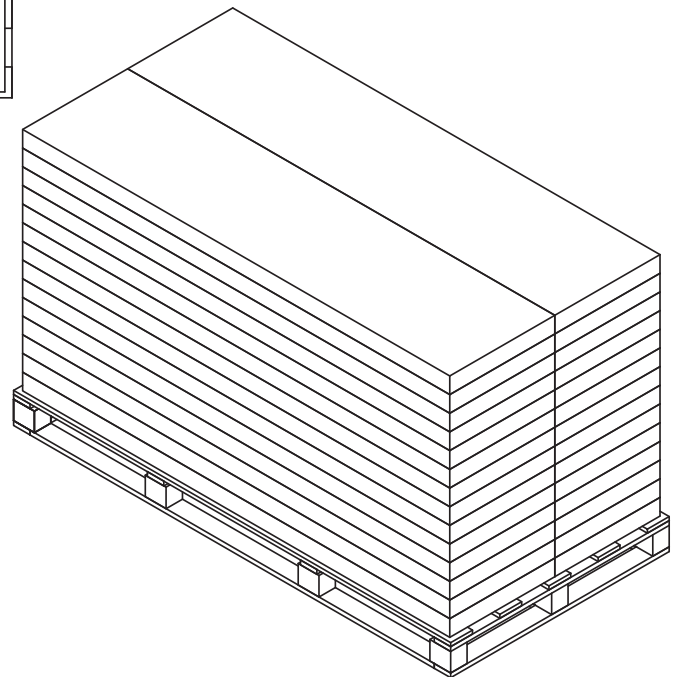
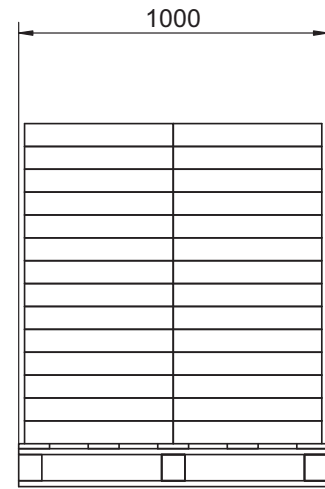
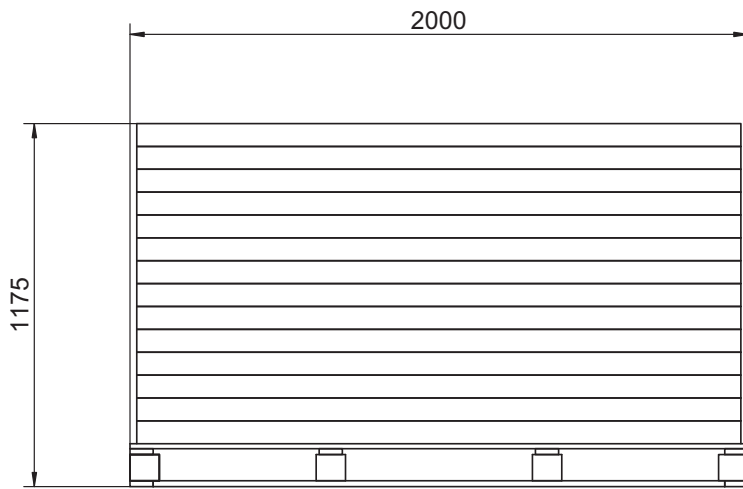
PALLETIZING



Rev.	Latest Revision / Description						
A	Første udgave.						
Item number	Component	Pcs.	L	W	T	Gross weight in kg	Net weight in kg
089154	Palle, TS12A, Special.	1	2000	1000	139		
Box 2 of 2		28	1955	481	74	31,0	29,9
tvilum 92176	Vitrine 2 låger Roomers		INIT:	JR	DATE :	16-03-2017	
			REVISION:	A	Approved by:	JR	
			DWG.NO.	92176-70			