

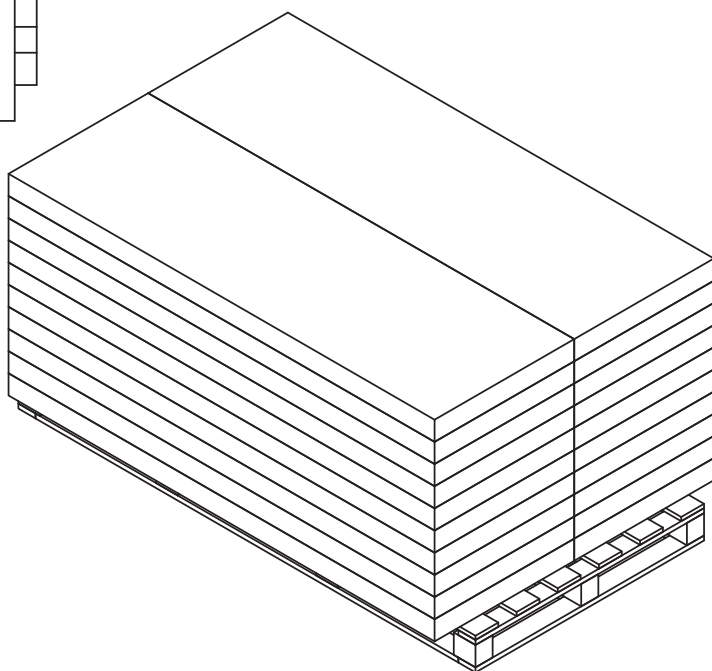

PALLETIZING

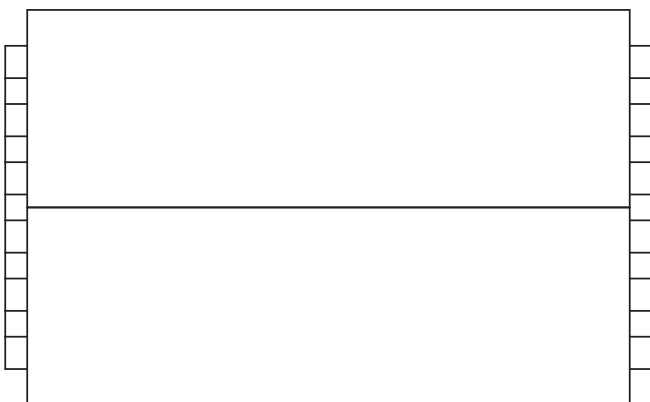
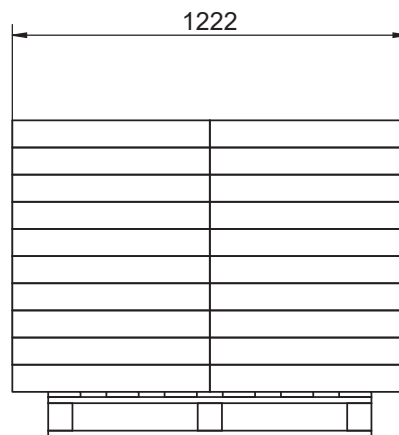
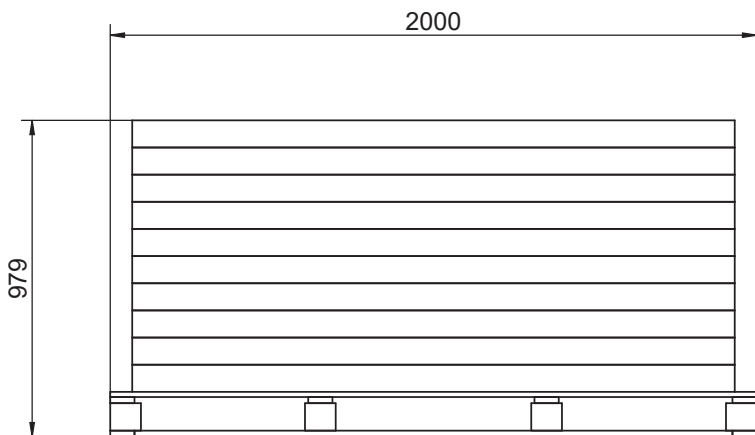
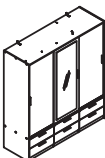
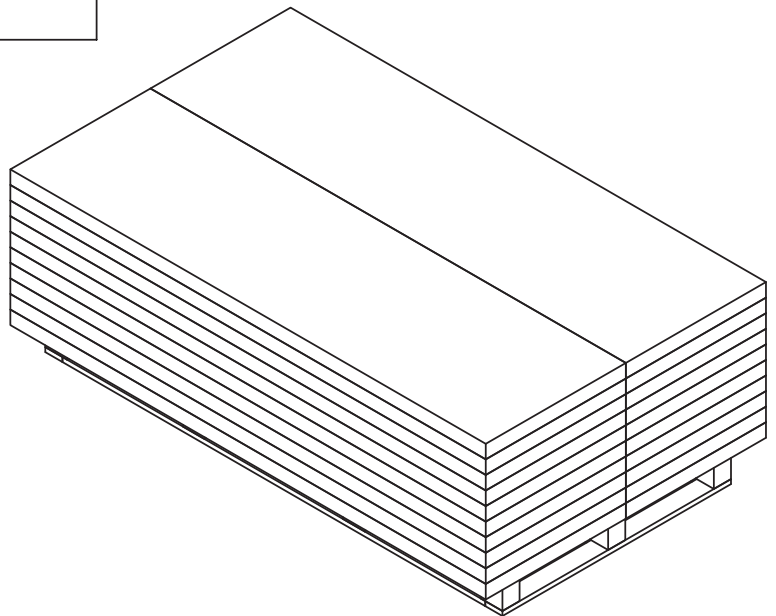
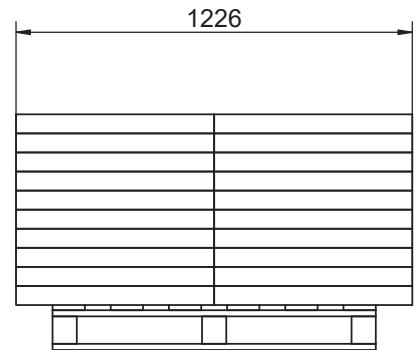
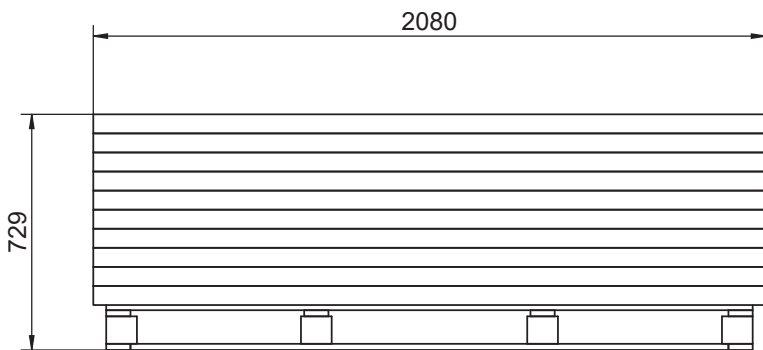

Rev.	Latest Revision / Description						
B	09-02-2023 JR (ECO EC-97): Palle 089641 TS66 ændret til 089154 TS12.						
Item number	Component	Pcs.	L	W	T	Gross weight in kg	Net weight in kg
089154	Palle, TS12A, Special	1	2000	1000	139	22	
Box 1 of 3		20	1864	611	84	43,9	42,4
tvilum 74320	Garderobeskab Line		INIT:	JR	DATE :	19-03-2018	
			REVISION:	B	Approved by:	JR	
			DWG.NO.	74320-70			

PALLETIZING



Rev.	Latest Revision / Description						
B	09-02-2023 JR (ECO EC-97): Palle 089641 TS66 ændres til 089154 TS12.						
Item number	Component	Pcs.	L	W	T	Gross weight in kg	Net weight in kg
089154	Palle, TS12A, Special	1	2000	1000	139	22	
Box 2 of 3		20	2080	613	59	43,1	41,8
tvilum 74320	Garderobeskab Line		INIT:	JR	DATE :	19-03-2018	
			REVISION:	B	Approved by:	JR	
			DWG.NO.	74320-70			

PALLETIZING

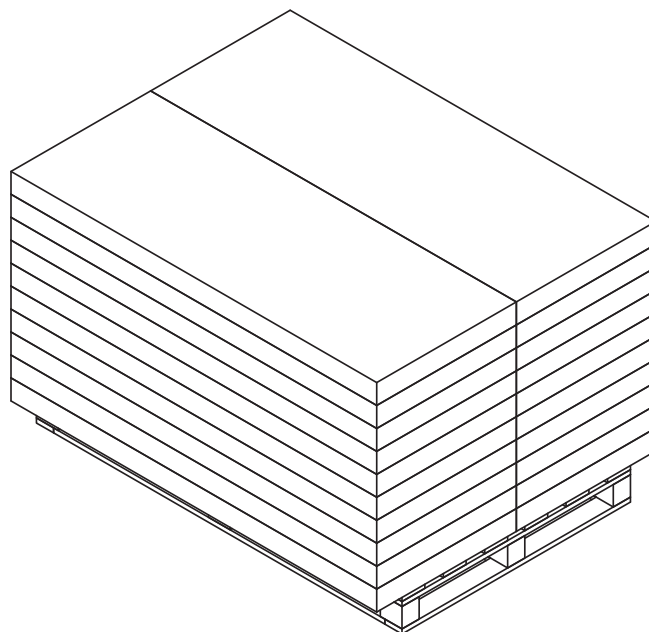
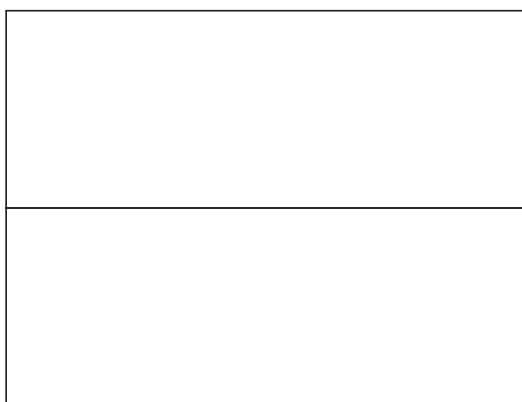
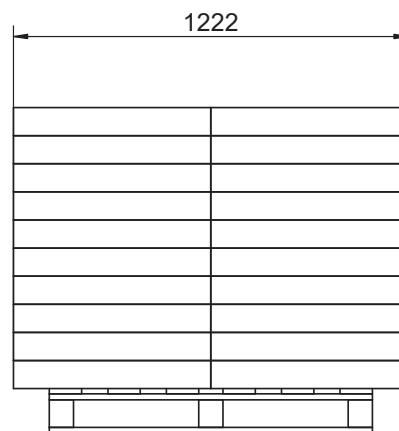
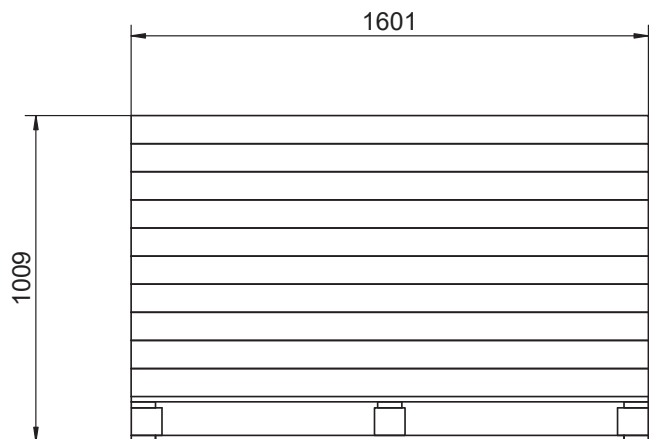

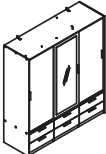
Rev.	Latest Revision / Description						
B	24-01-2023 JR (ECO EC-89): Palle 089113 TS40 ændret til palle 089106 TS1.						
Item number	Component	Pcs.	L	W	T	Gross weight in kg	Net weight in kg
089106	Palle, TS1A, Special	1	1600	1000	139	20	
Box 3 of 3		20	1601	611	87	46,4	45,2
tvilum	Garderobeskab Line		INIT:	JR	DATE :	19-03-2018	
			REVISION:	B	Approved by:	JR	
74320			DWG.NO.		74320-70		