

**SAVE BY TVILUM**

**YOUR  
PERSONAL  
WARDROBE**





Colour 49/uu

20001/68 Cabinet - 20001177 Sliding doors. Colour 49/49

20001/68 Cabinet - 20001182 Sliding door.



# DESIGN TO YOUR PREFERENCES



Save modular range is the smart wardrobe solution. Available in three heights; 200, 220 or 240 cm, with options of sliding or hinged doors and flexible in terms of size and space, as the width can be extended as required. Save internal panels and accessories can also be used for walk-in-closets.

The Save wardrobe is assembled with Tvilum's unique bracket system, SmartMount, which enables you to assemble the wardrobe next to the wall. Furthermore, SmartMount allows you to assemble the wardrobe front facing, and attach it directly to the wall after assembling it. This way, you get a more stable wardrobe, which is safer to use. In addition to this, you avoid heavy lifts and moving of the wardrobe.

You can find an instruction video for SmartMount on our website [www.tvilum.com](http://www.tvilum.com) under Support.

Solid bars in metal.



Exclusive metal handles for sliding doors – in line with the stylish design.



Installing LED lights is both a functional and stylish detail.

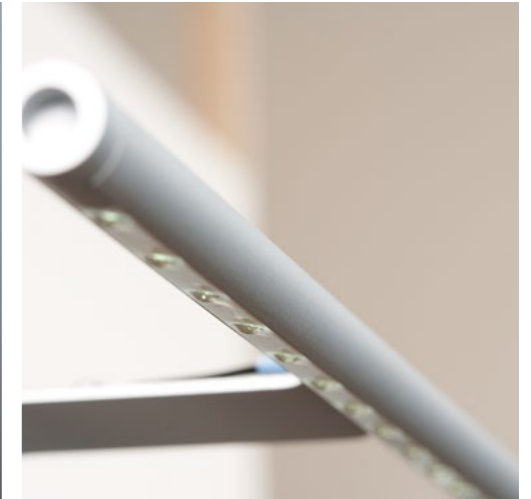

Optional divider for the drawers.



Opportunity for a personal touch with handles in four unique designs for hinged doors.



Drawers with metal runners.

Metal baskets for visible storage.

Sturdy shelves for storage.

# HOW TO DESIGN YOUR SLIDING WARDROBE

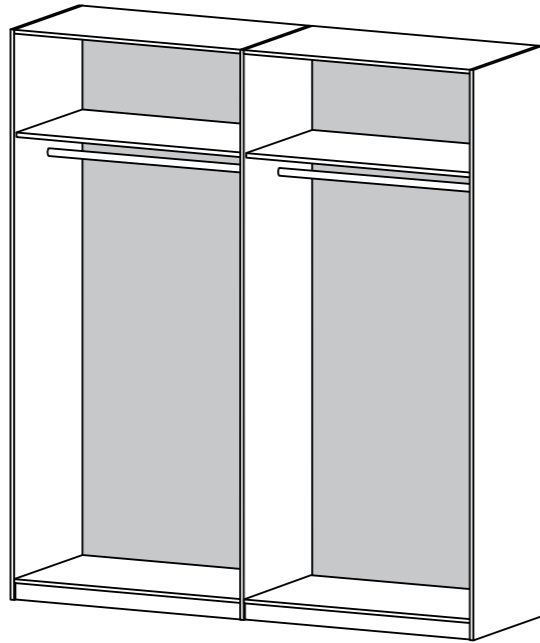

**STEP 1: CHOOSE FRAME**

+

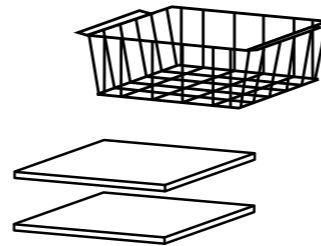

**STEP 2: CHOOSE ACCESSORIES**

+

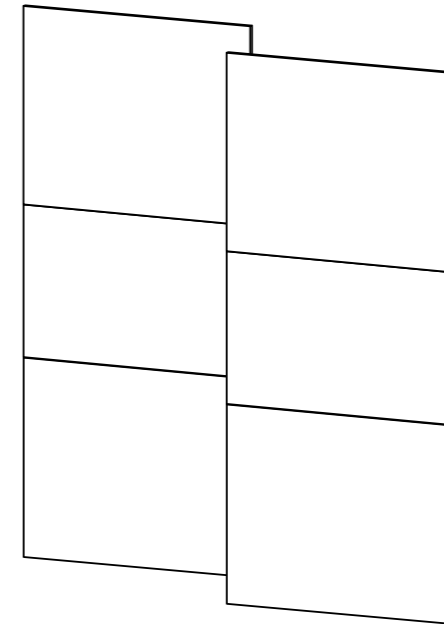

**STEP 3: CHOOSE DOORS**

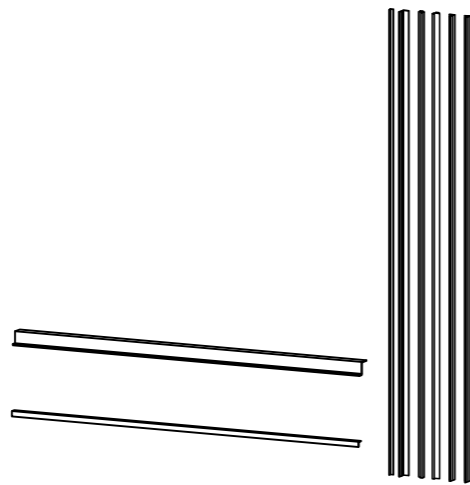

**STEP 4: CHOOSE BRACKETS**

+

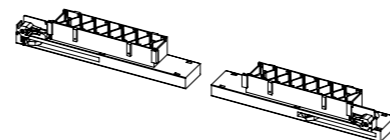

**STEP 5: CHOOSE DAMPER**

=

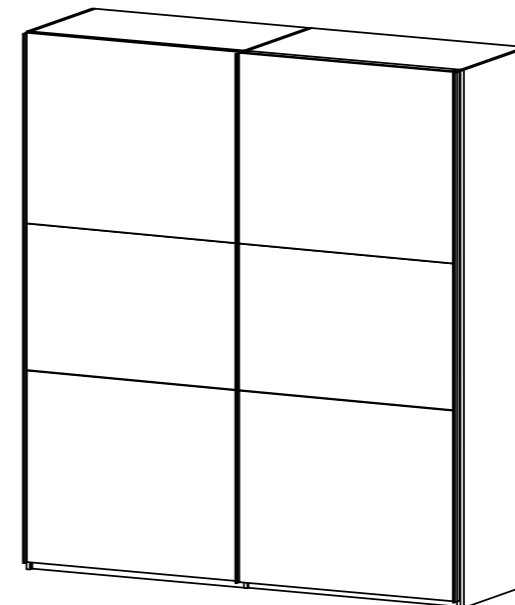

# HOW TO DESIGN YOUR HINGED WARDROBE

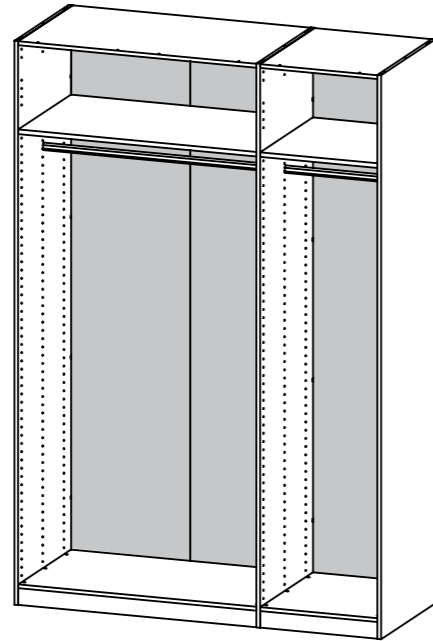

**STEP 1: CHOOSE FRAME**

+

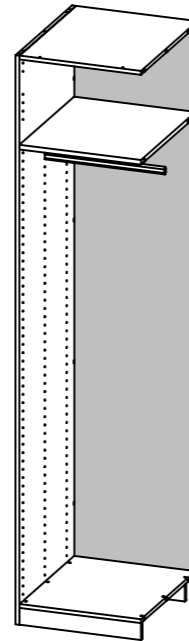

**STEP 2: CHOOSE OPTIONAL  
ADD ON**

+

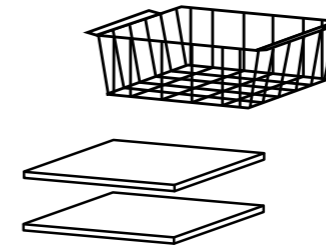

**STEP 3: CHOOSE ACCESSORIES**

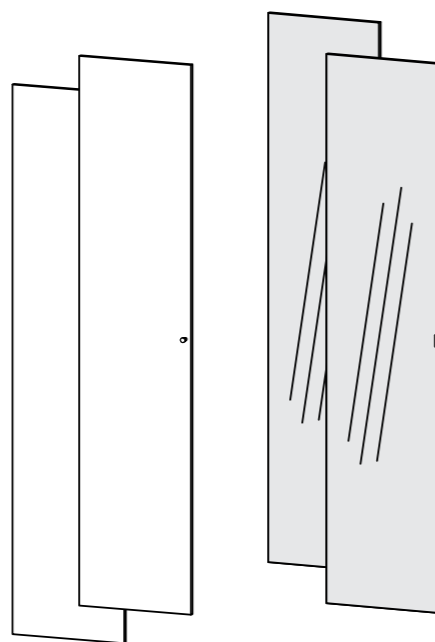

**STEP 4: CHOOSE DOORS**

+



**STEP 5: CHOOSE HANDLES**

=

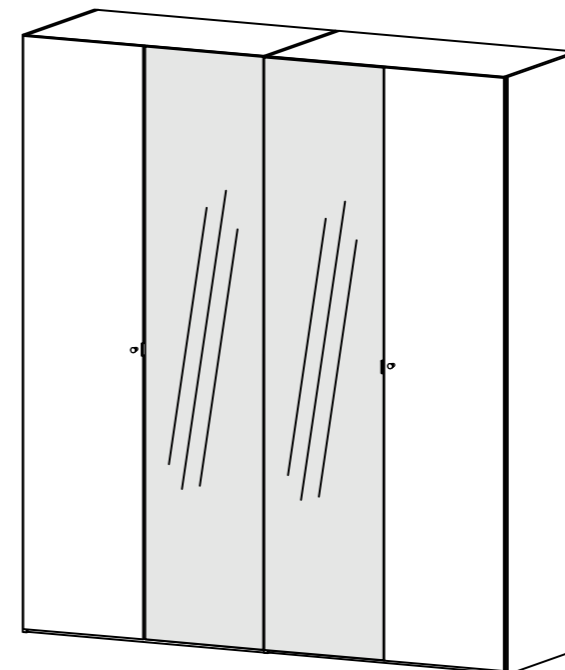

# SMARTMOUNT MAKES ASSEMBLY QUICK AND EASY

1. SmartMount is mounted from the front on the side of the wardrobe and secured to the wall before inserting the rear wardrobe panel.

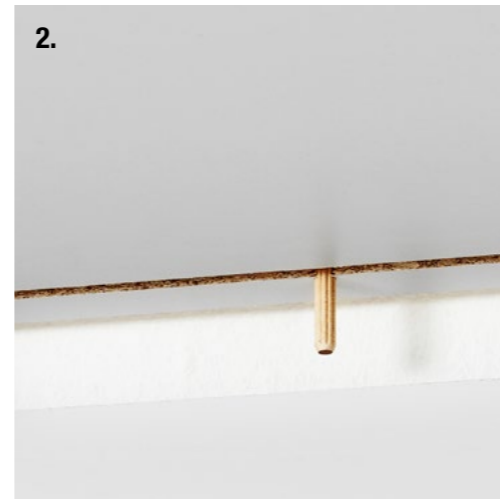
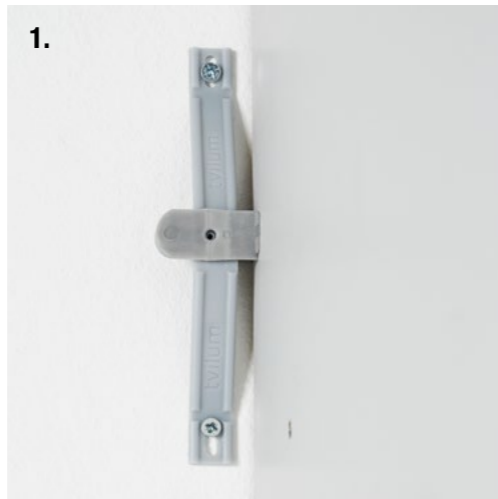

2. The rear panel is easily inserted into the groove at the top and bottom of the wardrobe. The dowel helps to make the operation even easier.

3. The last part of the bracket is attached to the side of the wardrobe and a screw is then inserted through the bracket and rear panel.

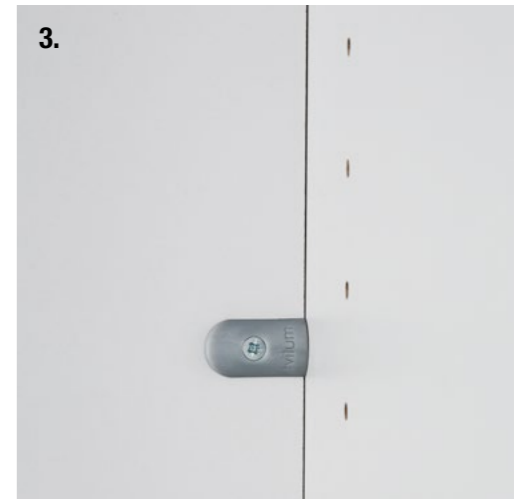

4. The bracket ensures that the wardrobe cannot tip over, providing stability in every direction. (Here the bracket is seen from the rear after mounting).





SmartMount seen from the rear after mounting. As illustrated in the diagram, there is no need to mount fittings and screws from the rear. Everything is mounted from the front.

### **About the unique SmartMount bracket**

With Tvilum's recently developed SmartMount assembly bracket, you can now assemble your wardrobe in your chosen location instead of having to move a heavy wardrobe once it has been assembled. All fittings and screws are mounted from the front.

SmartMount improves safety, as the bracket enables you to secure the wardrobe to the wall, preventing it from tipping over and injuring children and others.

SmartMount also stabilises the wardrobe in every direction, thus extending the product's service life. Tvilum's SmartMount bracket also makes it faster and easier to assemble a large wardrobe. All in all, SmartMount solves several traditional challenges associated with flat packed furniture at one and the same time.

## CABINETS

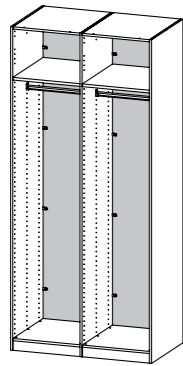

### 20001/66 Cabinet

98.5 x 58 x 199.4 cm  
38.8 x 22.8 x 78.5"

### 20001/59 Cabinet

98.5 x 58 x 218.6 cm  
38.8 x 22.8 x 86.1"

For hinged doors  
Colours: 49 - ak

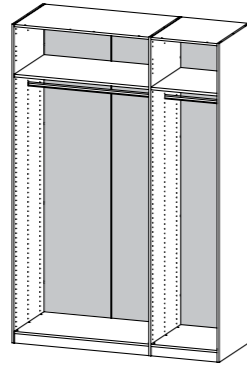

### 20001/67 Cabinet

147 x 58 x 199.4 cm  
57.9 x 22.8 x 78.5"

### 20001/60 Cabinet

147 x 58 x 218.6 cm  
57.9 x 22.8 x 86.1"

For hinged doors  
Colours: 49 - ak

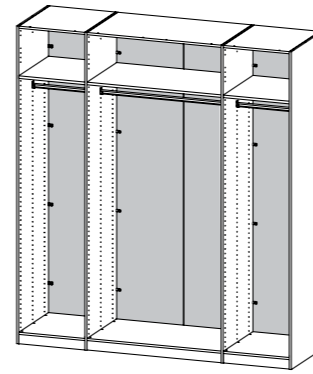

### 20001/167 Cabinet

195.5 x 58 x 199.4 cm  
77 x 22.8 x 78.5"

### 20001/71 Cabinet

195.5 x 58 x 218.6 cm  
77 x 22.8 x 86.1"

For hinged and sliding doors  
Colours: 49 - ak

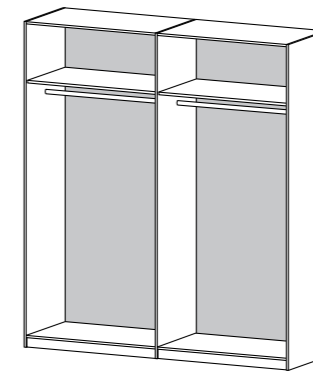

### 20001/68 Cabinet

195.5 x 58 x 199.4 cm  
77 x 22.8 x 78.5"

### 20001/61 Cabinet

195.5 x 58 x 218.6 cm  
77 x 22.8 x 86.1"

For hinged and sliding doors  
Colours: 49 - ak

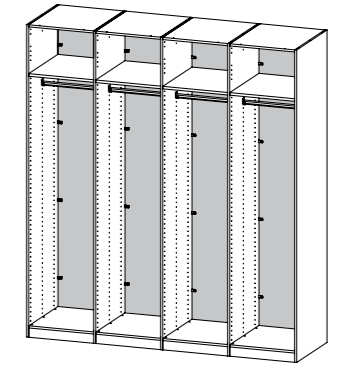

### 20001/189 Cabinet

195.5 x 58 x 199.4 cm  
77 x 22.8 x 78.5"

### 20001/72 Cabinet

195.5 x 58 x 218.6 cm  
77 x 22.8 x 86.1"

For hinged and sliding doors  
Colours: 49 - ak

## CABINETS

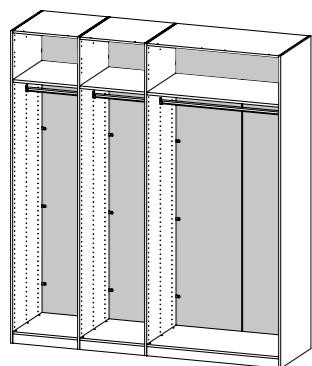

### **20001/239 Cabinet**

195.5 x 58 x 199.4 cm  
77 x 22.8 x 78.5"

### **20001/70 Cabinet**

195.5 x 58 x 218.6 cm  
77 x 22.8 x 86.1"

For hinged and sliding doors  
Colours: 49 - ak

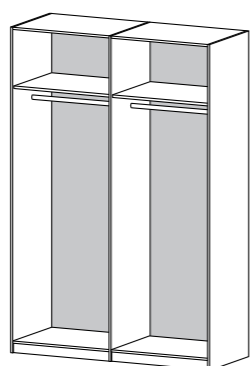

### **20001/146 Cabinet**

147 x 58 x 199.4 cm  
59.7 x 22.8 x 78.5"

### **20001/62 Cabinet**

147 x 58 x 218.6 cm  
59.7 x 22.8 x 86.1"

For sliding doors  
Colours: 49 - ak

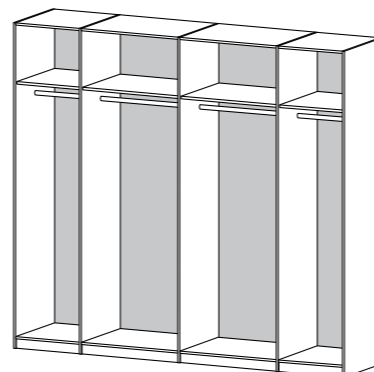

### **20001/156 Cabinet**

244 x 58 x 199.4 cm  
96.1 x 22.8 x 78.5"

### **20001/63 Cabinet**

244 x 58 x 218.6 cm  
96.1 x 22.8 x 86.1"

For sliding doors  
Colours: 49 - ak

## ADD ON AND CORNER UNIT

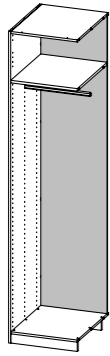

### **2000173 Add on**

48.5 x 58 x 199.4 cm  
19.1 x 22.8 x 78.5"

### **2000110 Add on**

48.5 x 58 x 218.6 cm  
19.1 x 22.8 x 86.1"

Colour: 59

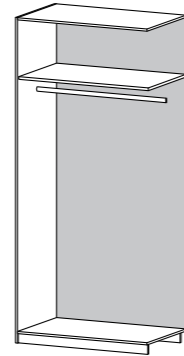

### **20001/69 Add on**

97 x 58 x 199.4 cm  
38.2 x 22.8 x 78.5"

### **20001/64 Add on**

97 x 58 x 218.6 cm  
38.2 x 22.8 x 86.1"

Colour: 59

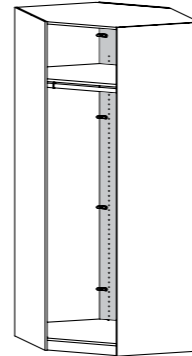

### **20001/176 Corner solution**

134.1 x 82.6 x 218.6 cm  
37.3 x 32.5 x 86.1"

Colours: 49 - ak

When building a corner solution only use  
this Save corner and add on's.

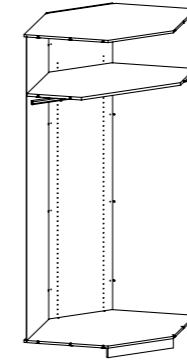

### **20001/204 Corner solution**

132 x 80 x 218.6 cm  
52 x 31.5 x 86.1"

Colour: 59

When building a corner solution only use  
this Save corner and add on's.

---

## SLIDING DOORS

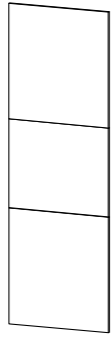

### 20001175 Sliding door

73.6 x 1.5 x 196.2 cm  
29 x 0.6 x 77.2"

Colour: 49

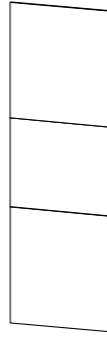

### 20001176 Sliding door

73.6 x 1.5 x 196.2 cm  
29 x 0.6 x 77.2"

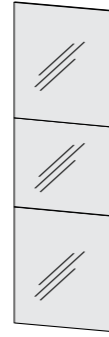

### 20001181 Sliding door

73.6 x 1.2 x 196.2 cm  
29 x 0.6 x 77.2"



### 20001177 Sliding door

97.8 x 1.5 x 196.2 cm  
38.5 x 0.6 x 77.2"

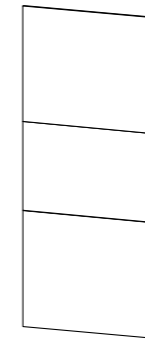

### 20001178 Sliding door

97.8 x 1.5 x 196.2 cm  
38.5 x 0.6 x 77.2"

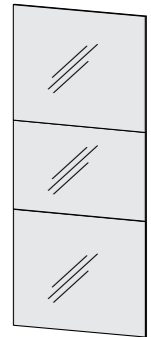

### 20001182 Sliding door

97.8 x 1.2 x 196.2 cm  
38.5 x 0.5 x 77.2"

### 2000118 Sliding door

73.6 x 1.5 x 215.4 cm  
29 x 0.6 x 84.8"

Colours: 49 - ak

### 2000120 Sliding door

73.6 x 1.5 x 215.4 cm  
29 x 0.6 x 84.8"

Colour: uu

### 2000121 Sliding door

73.6 x 1.2 x 215.4 cm  
29 x 0.5 x 84.8"

Mirror

### 2000122 Sliding door

97.8 x 1.5 x 215.4 cm  
38.5 x 0.6 x 84.8"

Colour: 49

### 2000124 Sliding door

97.8 x 1.5 x 215.4 cm  
38.5 x 0.6 x 84.8"

Colour: uu

### 2000125 Sliding door

97.8 x 1.2 x 215.4 cm  
38.5 x 0.5 x 84.8"

Mirror

## SLIDING DOORS

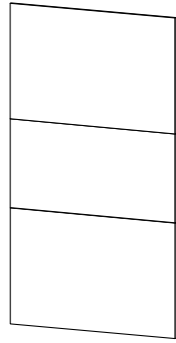

**20001179 Sliding door**  
122.1 x 1.5 x 196.2 cm  
48.1 x 0.6 x 77.2"

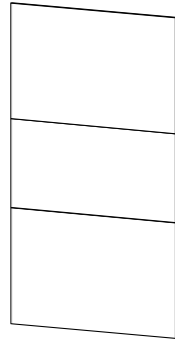

**20001180 Sliding door**  
122.1 x 1.5 x 196.2 cm  
48.1 x 0.6 x 77.2"



**2000129 Sliding door**  
122.1 x 1.2 x 215.4 cm  
48.1 x 0.5 x 84.8"  
Mirror

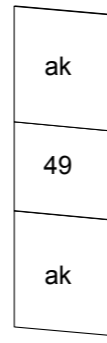

**2000119 Sliding door**  
73.6 x 1.5 x 215.4 cm  
29 x 0.6 x 84.8"

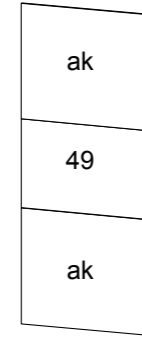

**20001170 Sliding door**  
97.8 x 1.5 x 196.2 cm  
38.5 x 0.6 x 77.2"

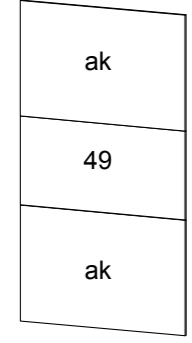

**20001174 Sliding door**  
122.1 x 1.5 x 196.2 cm  
48.1 x 0.6 x 77.2"

**2000126 Sliding door**  
122.1 x 1.5 x 215.4 cm  
48.1 x 0.6 x 84.8"  
Colour: 49

**2000128 Sliding door**  
122.1 x 1.5 x 215.4 cm  
48.1 x 0.6 x 84.8"  
Colour: uu

**2000123 Sliding door**  
97.8 x 1.5 x 215.4 cm  
38.5 x 0.6 x 84.8"

**2000127 Sliding door**  
122.1 x 1.5 x 215.4 cm  
48.1 x 0.6 x 84.8"

## DOORS



### 2000164 Door

48.2 x 1.5 x 198.1 cm  
19 x 0.6 x 78"



### 2000165 Door

48.2 x 1.5 x 198.1 cm  
19 x 0.6 x 78"

### 2000112 Door

48.2 x 1.5 x 217.3 cm  
19 x 0.6 x 85.6"

Colours: 49 - ak

### 2000115 Door

48.2 x 1.5 x 217.3 cm  
19 x 0.6 x 85.6"

Colour: uu

### 2000113 Door

48.2 x 1.5 x 217.3 cm  
19 x 0.6 x 85.6"

Mirror

## WARDROBES



### 75302 Wardrobe

98.5 x 59.6 x 218.6 cm  
38.8 x 23.5 x 86.1"

Colour: 49uu

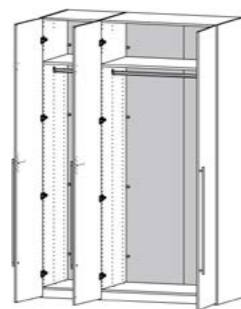

### 75303 Wardrobe

147 x 59.6 x 218.6 cm  
57.8 x 23.5 x 86.1"

Colour: 49uu

## ACCESSORIES



### 2000137 2 Shelves

47 x 55.9 x 1.8 cm  
18.5 x 22 x 0.7"  
Colour: 59



### 2000138 2 Shelves

71.3 x 55.9 x 1.8 cm  
28.1 x 22 x 0.7"  
Colour: 59



### 2000139 2 Shelves

95.5 x 55.9 x 1.8 cm  
37.6 x 22 x 0.7"  
Colour: 59



### 2000134 Metal bar

9 pcs.  
47 x 2.5 x 4.6 cm  
18.5 x 1 x 1.8"



### 2000135 Metal bar

9 pcs.  
71.2 x 2.5 x 4.6 cm  
28 x 1 x 1.8"



### 2000136 Metal bar

9 pcs.  
95.4 x 2.5 x 4.6 cm  
37.6 x 1 x 1.8"

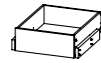

### 20001156 Drawer Softclose

47 x 51.5 x 15.7 cm  
18.5 x 20.3 x 6.2"  
Colour: 59

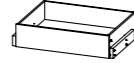

### 20001157 Drawer Softclose

71.2 x 51.5 x 15.7 cm  
28 x 20.3 x 6.2"  
Colour: 59



### 20001158 Drawer Softclose

95.5 x 51.5 x 15.7 cm  
37.6 x 20.3 x 6.2"  
Colour: 59

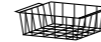

### 20001165 Metal basket with metal runners

47 x 50 x 15 cm  
18.5 x 19.7 x 5.9"

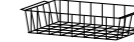

### 20001166 Metal basket with metal runners

71.3 x 50.8 x 15 cm  
28.1 x 19.7 x 5.9"



### 20001167 Metal basket with metal runners

95.5 x 50.8 x 15 cm  
37.6 x 19.7 x 5.9"

## DAMPERS



### 20001194 Dampers

2 pcs.  
for mounting in cabinets  
- for sliding doors



## HANDLES AND HANDLE PLATE (DISPLAY FOR STORE)



### 2000188 Handle

2 pcs.

Cannot be used for  
mirror door

17 x 0.7 x 2.8 cm  
6.7 x 0.3 x 1.1"



### 2000189 Handle

2 pcs.

Cannot be used for  
mirror- and combi doors

83.6 x 3.3 x 1.2 cm  
32.9 x 1.3 x 0.5"



### 2000190 Handle

2 pcs.

Cannot be used for  
mirror door

2.8 x 2.6 x 2.8 cm  
1.1 x 1 x 1.1"



### 2000191 Handle

2 pcs.

4.2 x 1.8 x 4.5 cm  
1.7 x 0.7 x 1.8"

## FITTINGS FOR SLIDING DOORS

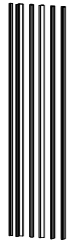

### Handle and Roller pack

20001193 (200)

20001192 (220)

Colour: 03

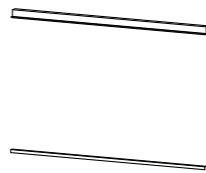

### 20001188 Sliding door bracket

1.5 m

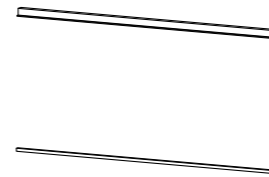

### 20001189 Sliding door bracket

2.0 m

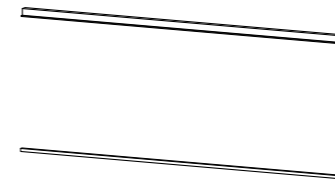

### 20001190 Sliding door bracket

2.5 m

## COLOURS

49

White

59

Silver grey

ak

Oak structure

uu

White high gloss

Measurements indicated as width x depth x height



02.22 - 10609 © Tvilum We accept no responsibility for printing errors or changes [www.tvilum.com](http://www.tvilum.com)

# tvilum

## THE BETTER FURNITURE PARTNER

Tvilum is Europe's leading supplier of practical, environmentally friendly furniture, designed for you and your home. We are a Danish company that produces with great care for the environment, people and nature.

