

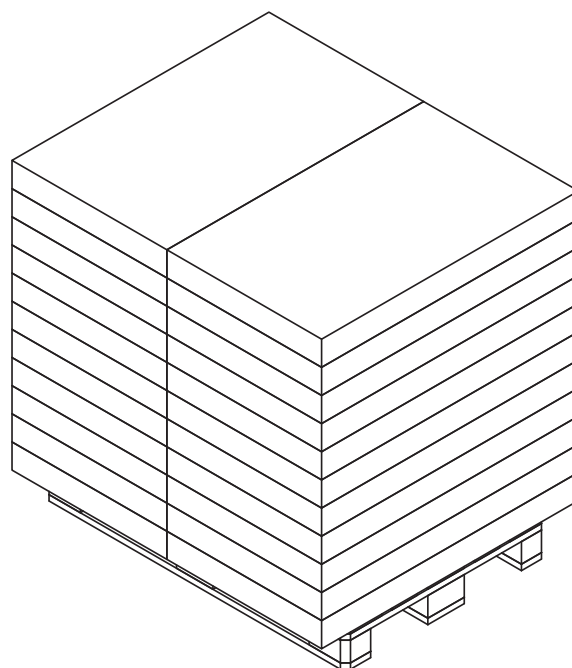

PALLETIZING

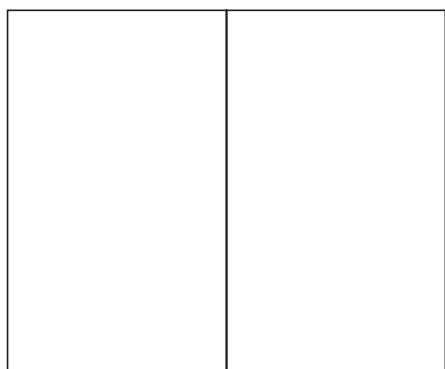
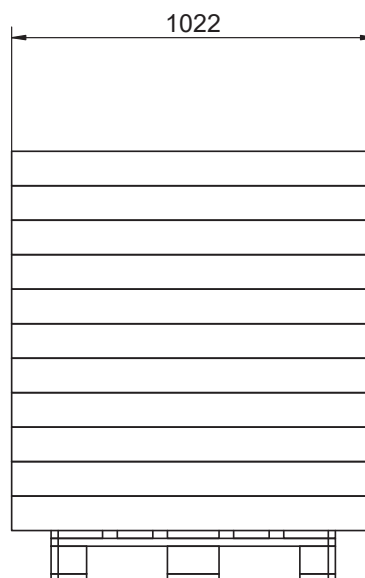
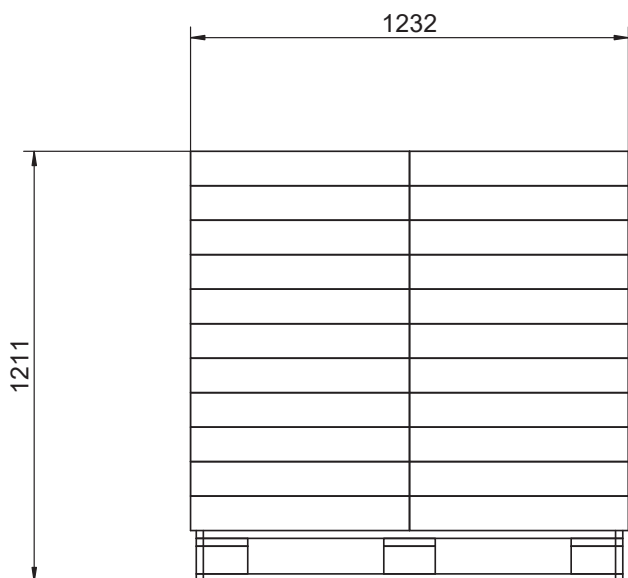

Rev.	Latest Revision / Description						
D	21-02-2019 JR (Finn): Palle TS50 089122y ændret til EUR-palle 089042y.						
Item number	Component	Pcs.	L	W	T	Gross weight in kg	Net weight in kg
089042y	Palle, EUR	1	1200	800	144	25 kg.	
Box 1 af 3		22	1022	616	97	28,2	27,3

tvilum	Garderobeskab 2 låger Paris		INIT:	BKA	DATE :	18-03-2009
			REVISION:	D	Approved by:	JR
75352			DWG.NO.		75352-70	

PALLETIZING

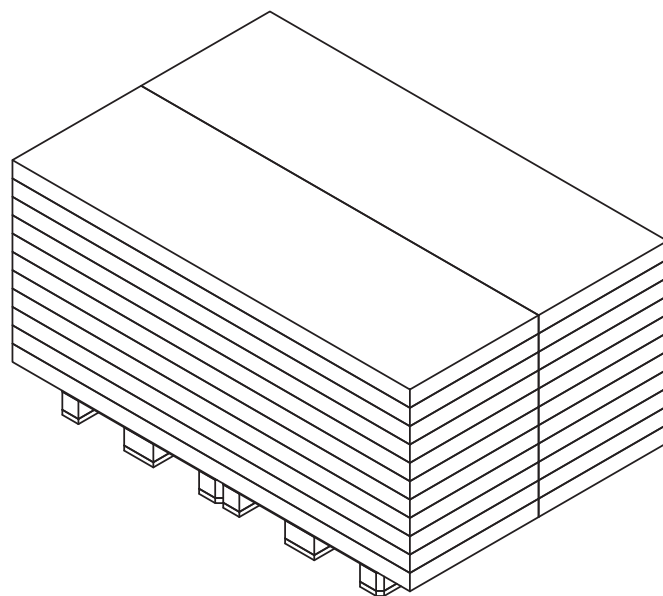
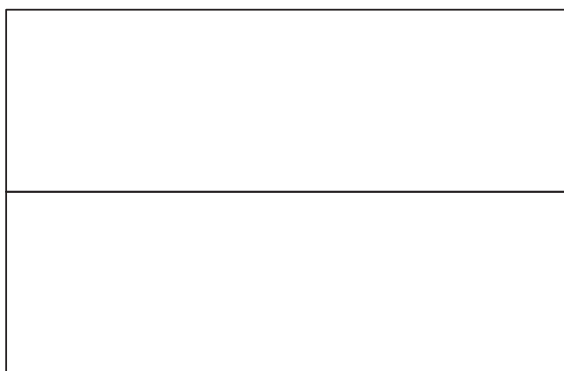
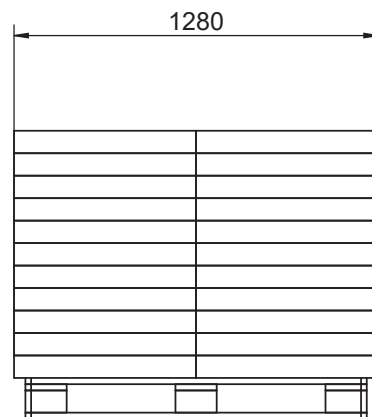
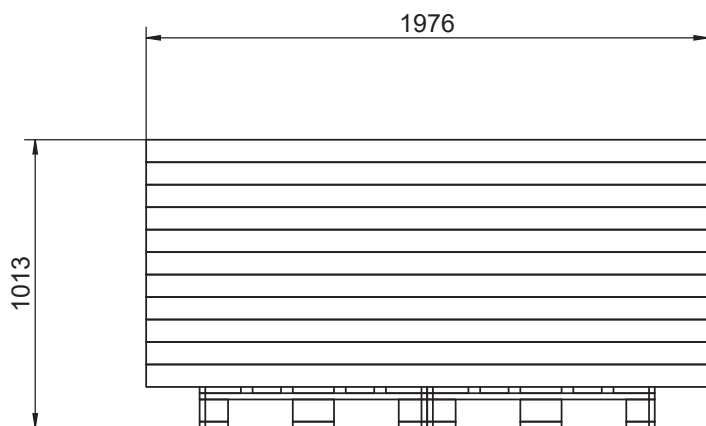

Rev.	Latest Revision / Description						
D	01-12-2021 JR (ECO 10898): Udv. mål ændret fra 1956x610x79 til 1976x640x79.						
Item number	Component	Pcs.	L	W	T	Gross weight in kg	Net weight in kg
089042y	Palle, EUR	2	1200	800	144	25 kg.	
Box 2 af 3		22	1976	640	79	31,3	29,7
tvilum	Garderobeskab 2 låger Paris		INIT:	BKA	DATE :	18-03-2009	
			REVISION:	D	Approved by:	JR	
75352			DWG.NO.		75352-70		

PALLETIZING

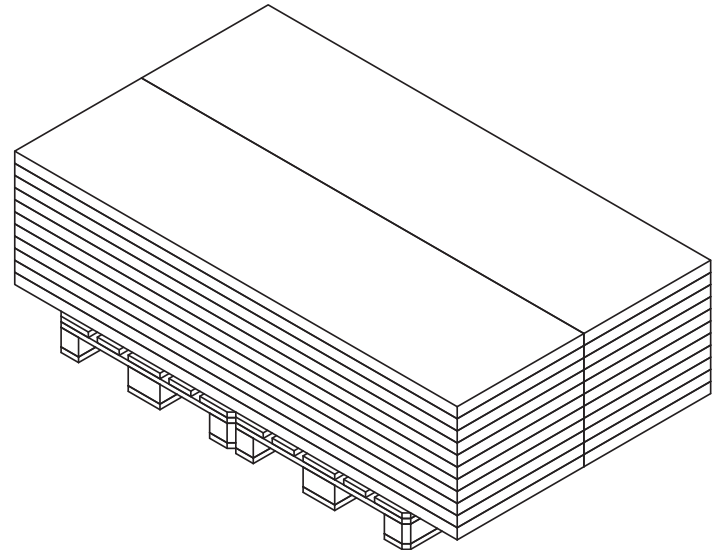
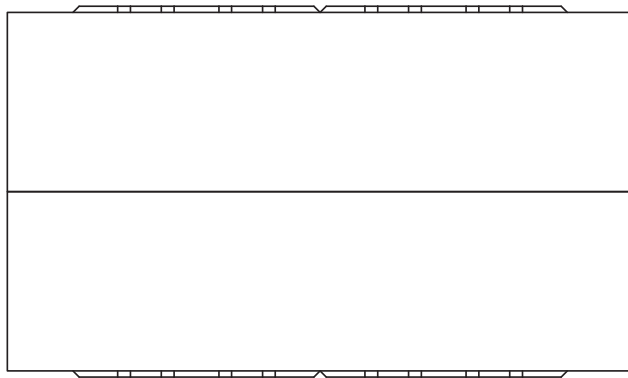
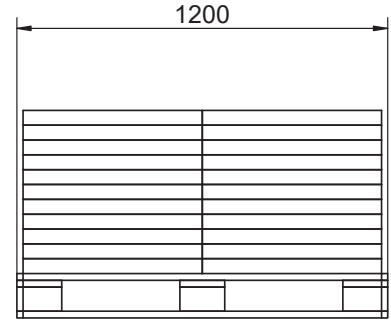
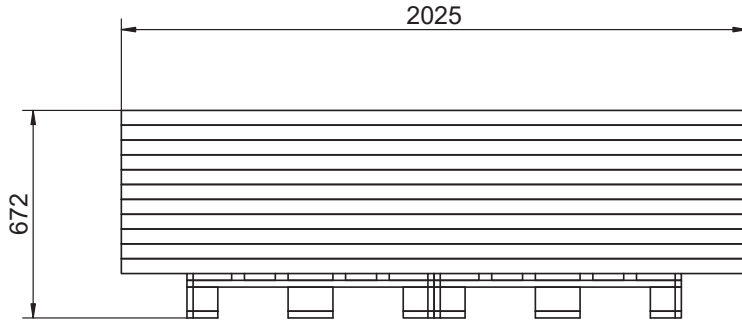

Rev.	Latest Revision / Description						
C	21-02-2019 JR (Finn): Palle TS50 089122y ændret til EUR-palle 089042y.						
Item number	Component	Pcs.	L	W	T	Gross weight in kg	Net weight in kg
089042y	Palle, EUR	2	1200	800	144	25 kg.	
Box 3 af 3		22	2025	580	48	28,3	27,1
tvilum 75352	Garderobeskab 2 låger Paris		INIT:	BKA	DATE :	18-03-2009	
			REVISION:	C	Approved by:	JR	
			DWG.NO.		75352-70		