

PALLETIZING

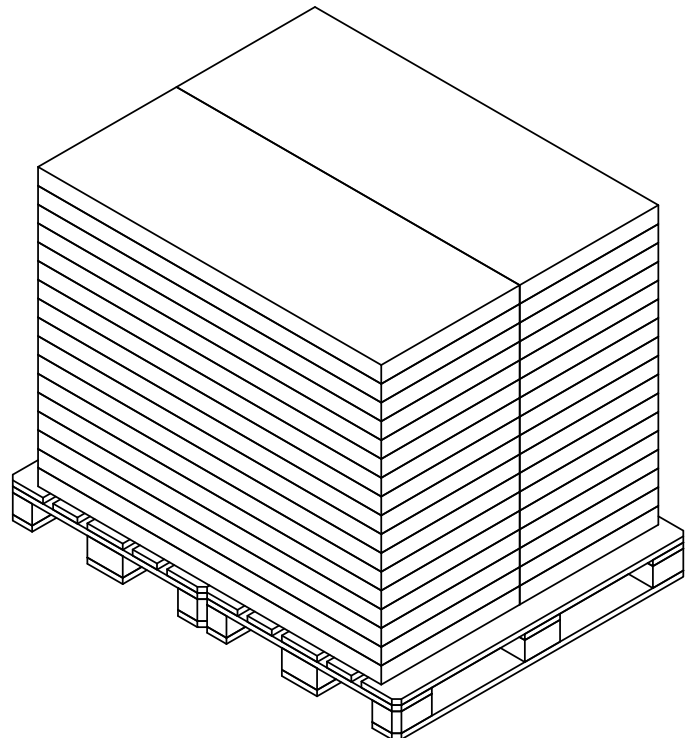

Rev.	Latest Revision / Description						
A	Første udgave.						
Item number	Component	Pcs.	L	W	T	Gross weight in kg	Net weight in kg
089042y	Palle, EUR	2	1200	800	144	25 kg.	
Box 1 of 5		34	1413	570	67	27,2	26,3
tvilum	Korpus Verona		INIT:	JR	DATE :	11-12-2018	
			REVISION:	A	Approved by:	JR	
75342				DWG.NO.	75342-70		

PALLETIZING

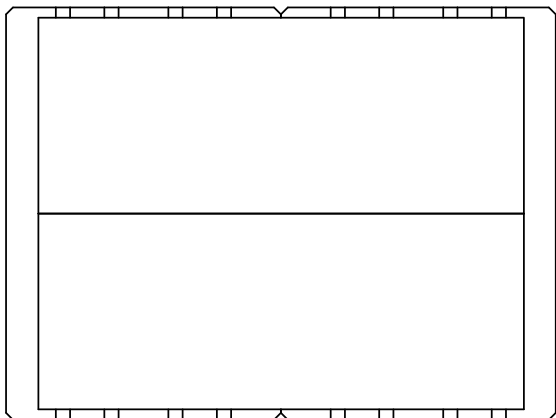
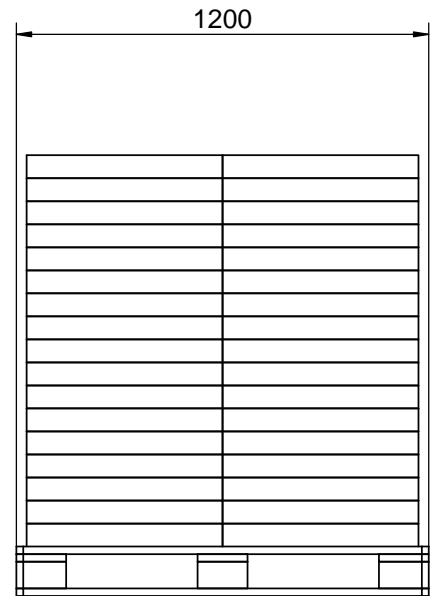
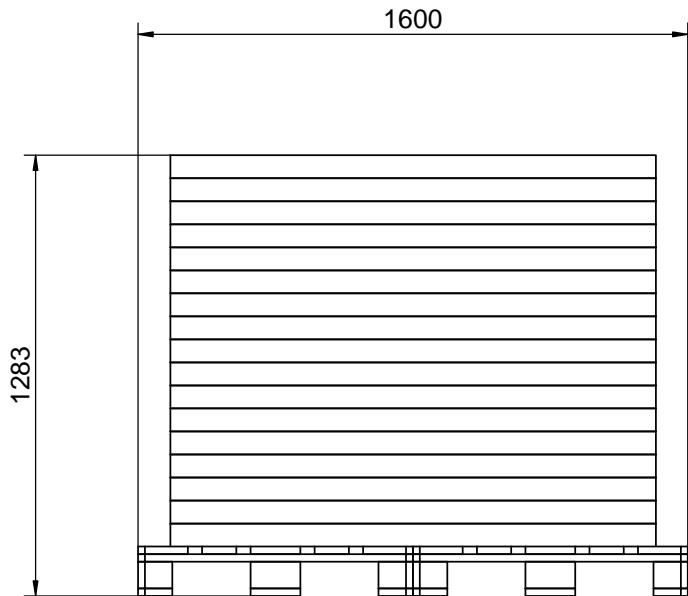
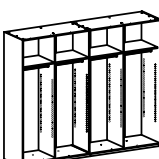
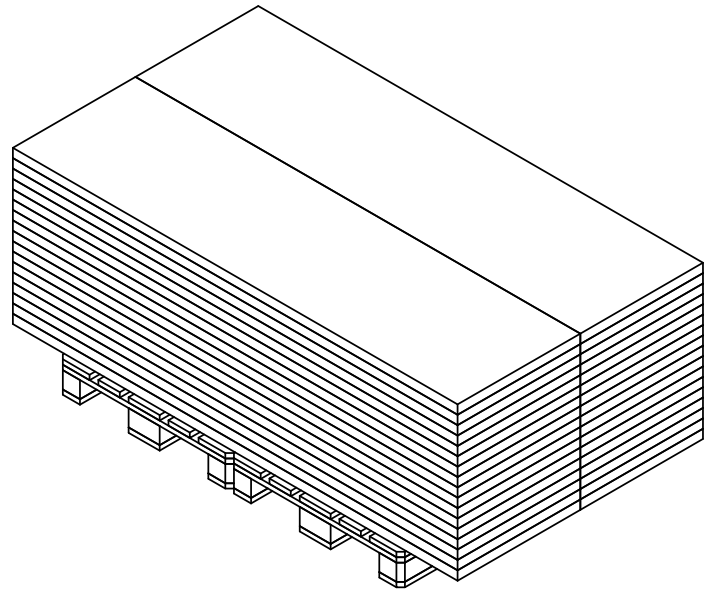
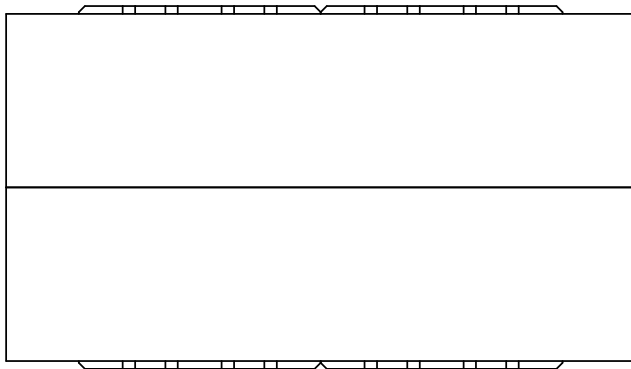
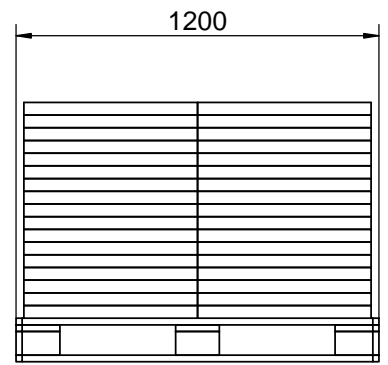
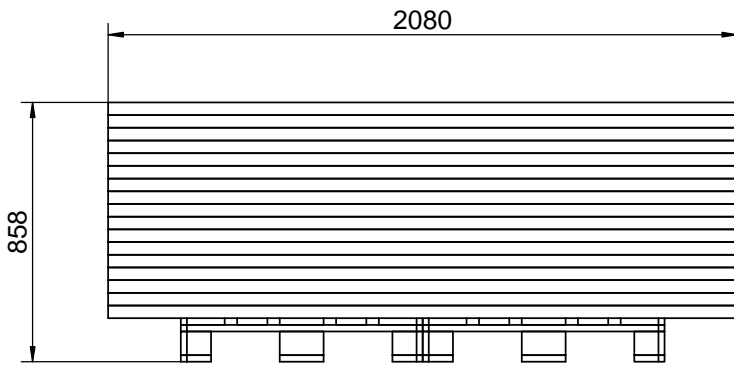

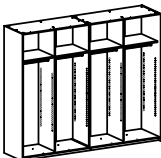
Rev.	Latest Revision / Description						
A	Første udgave.						
Item number	Component	Pcs.	L	W	T	Gross weight in kg	Net weight in kg
089042y	Palle, EUR	2	1200	800	144	25 kg.	
Box 2 of 5		34	2080	574	42	25,2	24,0
tvilum	Korpus Verona		INIT:	JR	DATE :	12-12-2018	
			REVISION:	A	Approved by:	JR	
75342			DWG.NO.		75342-70		

PALLETIZING

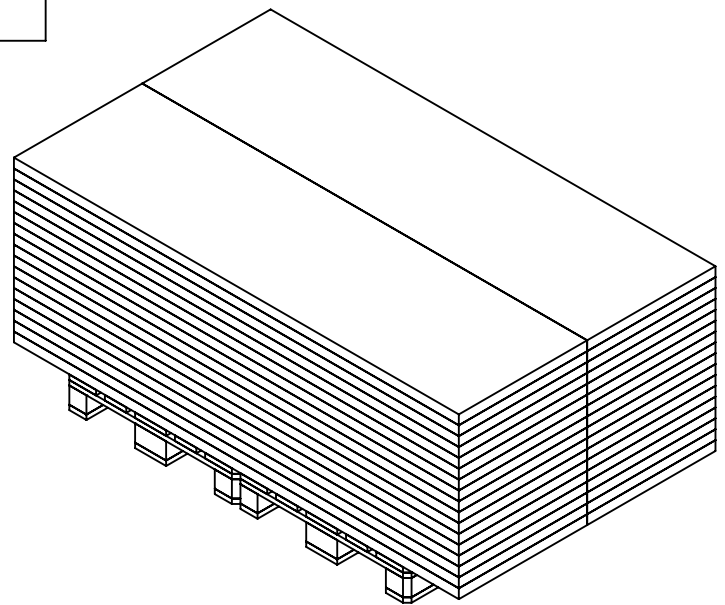
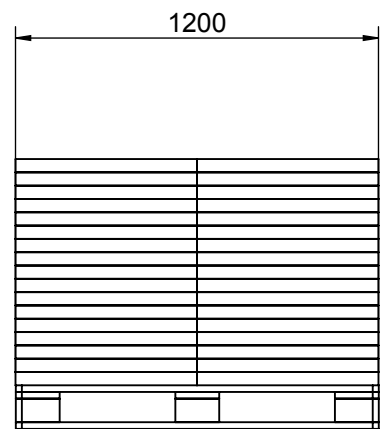
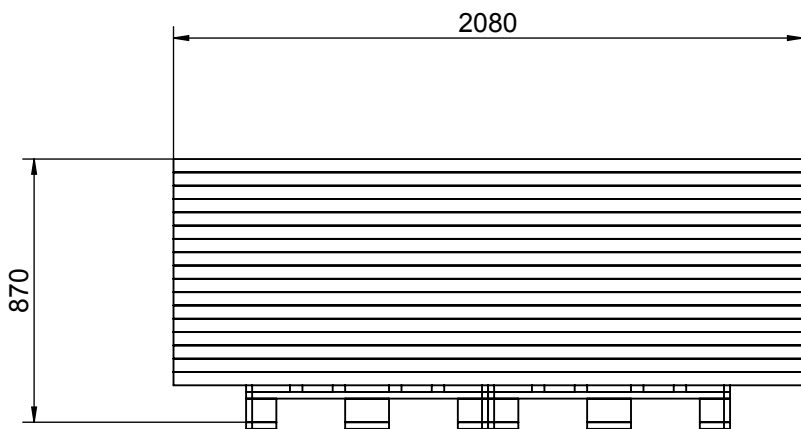

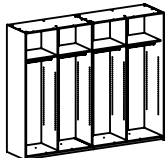
Rev.	Latest Revision / Description						
C	05-10-2020 JR (ECO 10735): Udv. mål ændret til 2080x600x44.						
Item number	Component	Pcs.	L	W	T	Gross weight in kg	Net weight in kg
089042y	Palle, EUR	2	1200	800	144	25 kg.	
Box 3 of 5		34	2080	600	44	19,9	18,7
tvilum 75342	Korpus Verona		INIT:	JR	DATE :	12-12-2018	
			REVISION:	C	Approved by:	JR	
			DWG.NO.		75342-70		

PALLETIZING

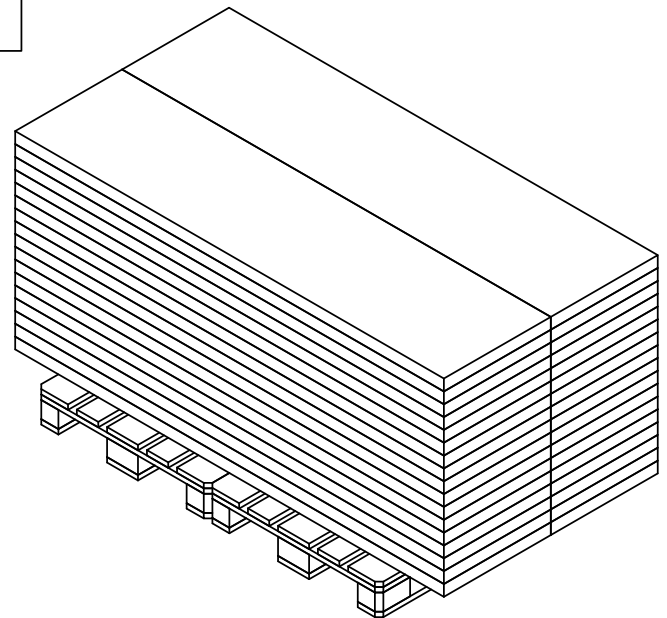
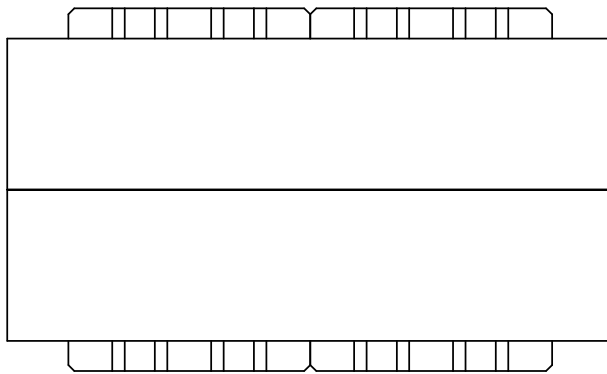
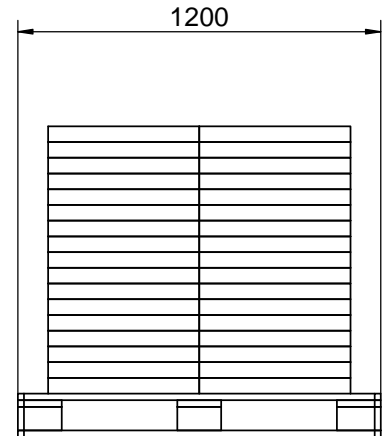
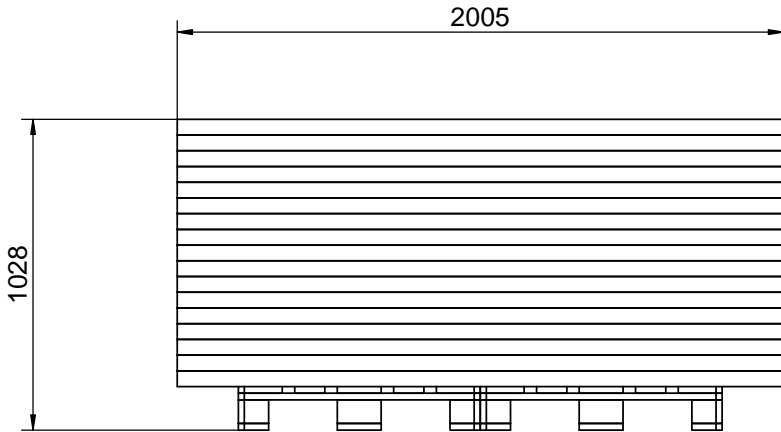

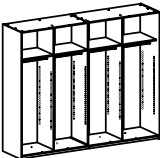
Rev.	Latest Revision / Description						
A	Første udgave.						
Item number	Component	Pcs.	L	W	T	Gross weight in kg	Net weight in kg
089042y	Palle, EUR	2	1200	800	144	25 kg.	
Box 4 of 5		34	2005	500	52	27,5	26,5
tvilum	Korpus Verona		INIT:	JR	DATE :	12-12-2018	
			REVISION:	A	Approved by:	JR	
75342			DWG.NO.		75342-70		

PALLETIZING

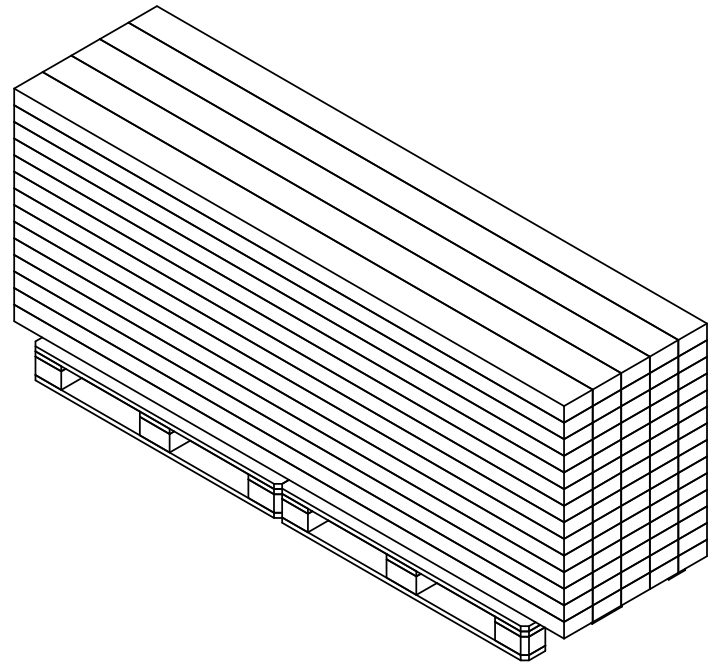
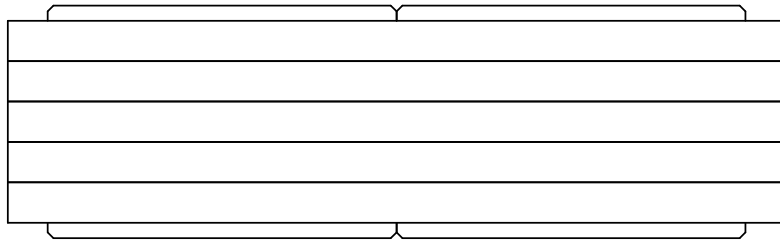
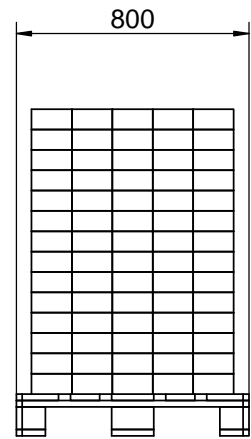
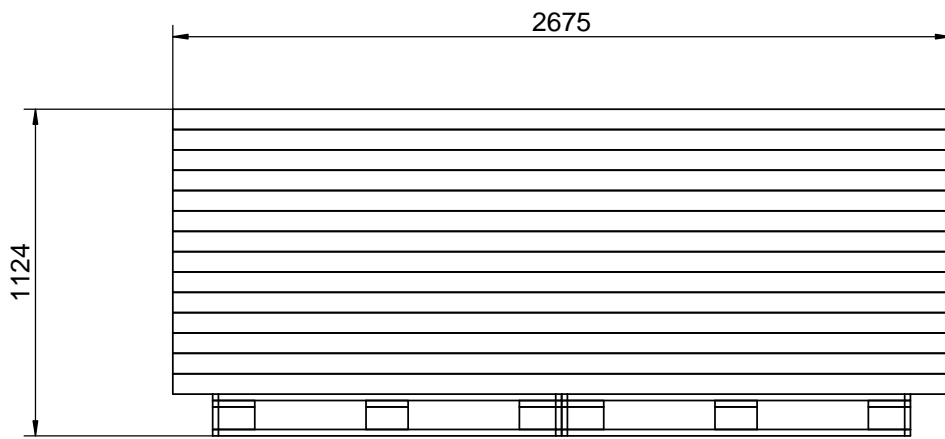

**Notat: Indkøbt vare
Beslagskasse fra Hettich 01p3330.
Bruges også til 75285.**

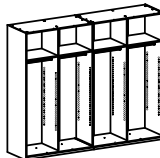
Rev.	Latest Revision / Description						
A	Første udgave.						
Item number	Component	Pcs.	L	W	T	Gross weight in kg	Net weight in kg
089042y	Palle, EUR	2	1200	800	144	25 kg.	
Box 5 of 5		70	2675	139	70	5,4	5,0
tvilum	Korpus Verona		INIT:	JR	DATE :	12-12-2018	
			REVISION:	A	Approved by:	JR	
75342				DWG.NO.	75342-70		