

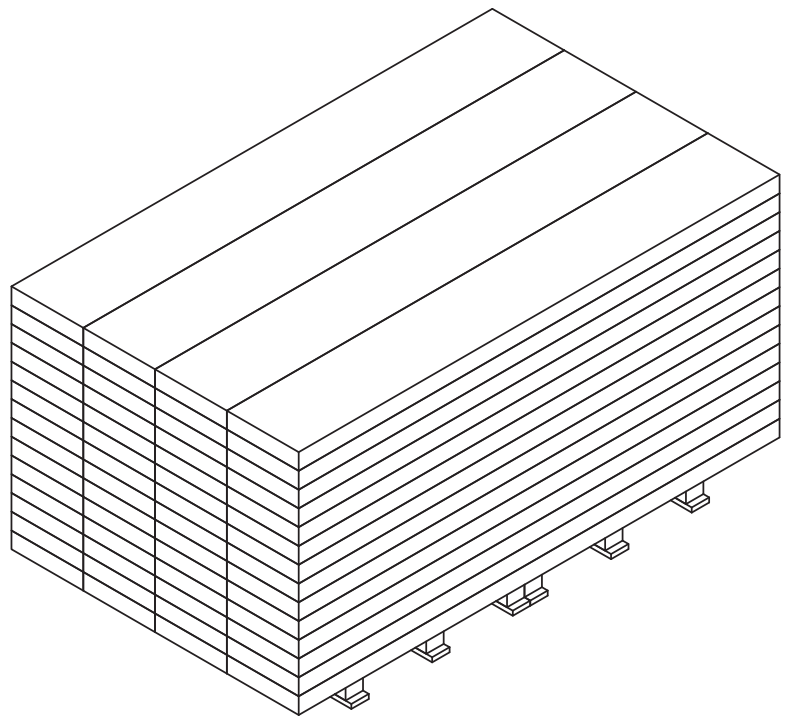

PALLETIZING

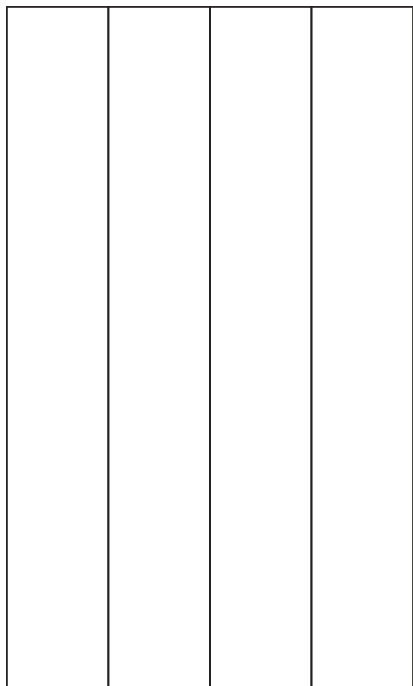
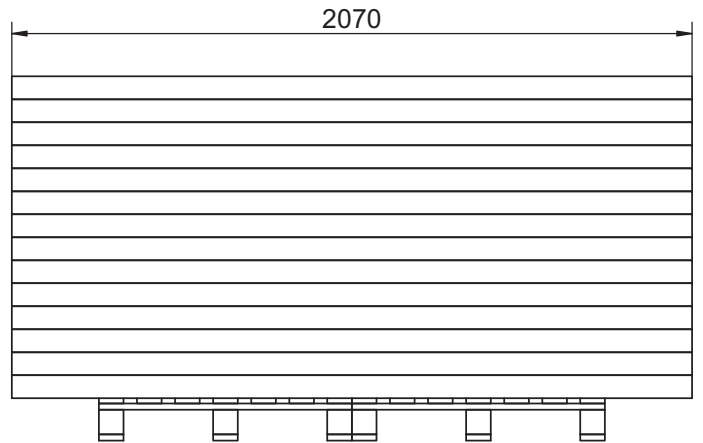
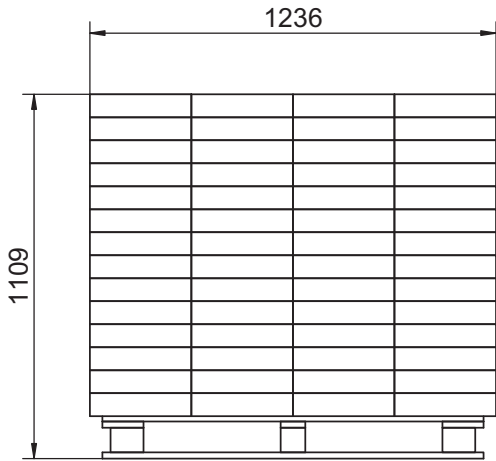

Rev.	Latest Revision / Description						
E	Vægt er opdateret.						
Item number	Component	Pcs.	L	W	T	Gross weight in kg	Net weight in kg
089122y	Palle, TS50, Special.	2	1160	770	129		
Box 1 af 3		56	2070	309	70	15,9	15,0
	Seng Paris		INIT:	BKA	DATE :	16-03-2009	
			REVISION:	E	Approved by:	JR	
76701-702-703		DWG.NO.		76701-702-703 -70			

PALLETIZING

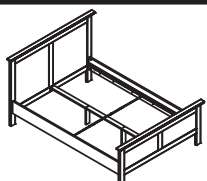
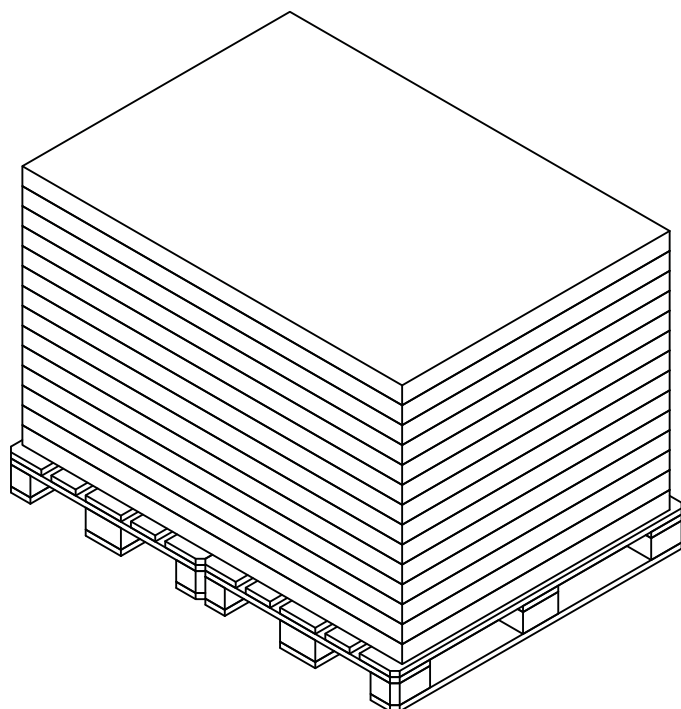
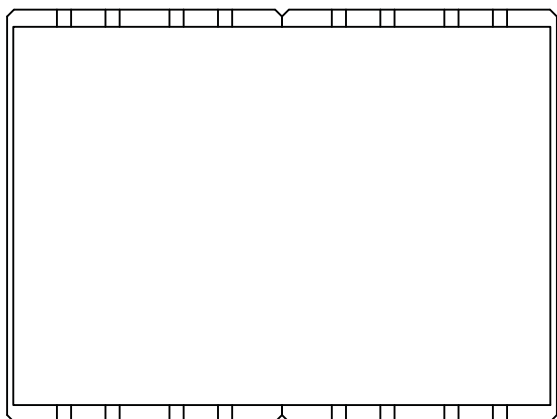
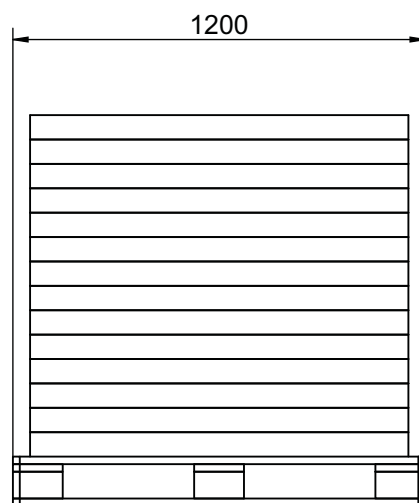
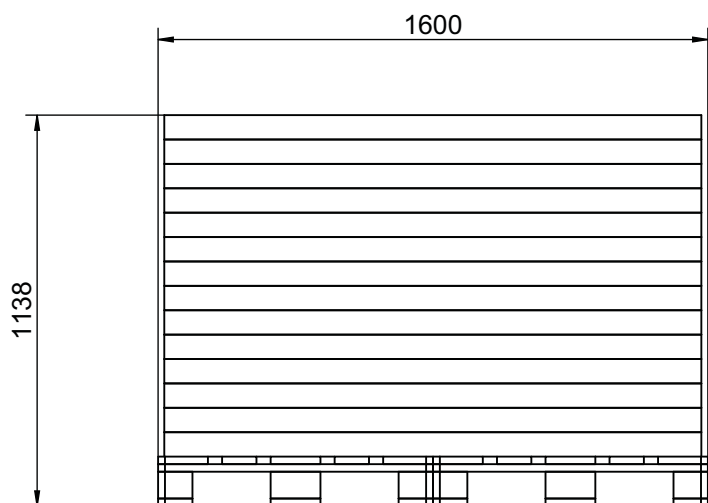

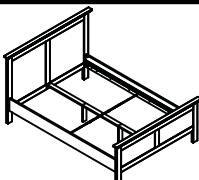
Rev.	Latest Revision / Description						
C	Palle TS40 089113 ændret til 2 stk. EUR-palle 089042y.						
Item number	Component	Pcs.	L	W	T	Gross weight in kg	Net weight in kg
089042y	Palle, EUR	2	1200	800	144		
Box 2 af 3		14	1563	1101	71	32,6	29,9
tvilum	Seng Paris		INIT:	JR	DATE :	16-03-2009	
			REVISION:	C	Approved by:	JR	
76701-77802			DWG.NO.		76701-77802-70		

PALLETIZING

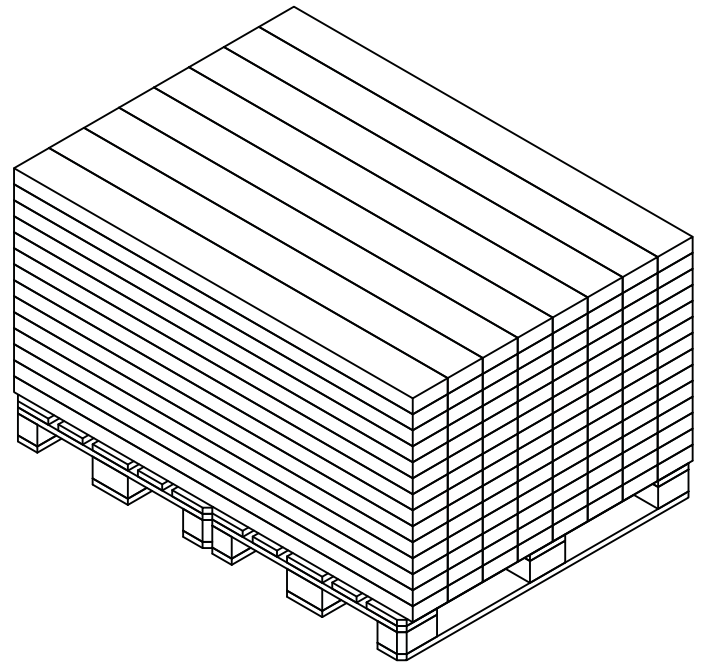
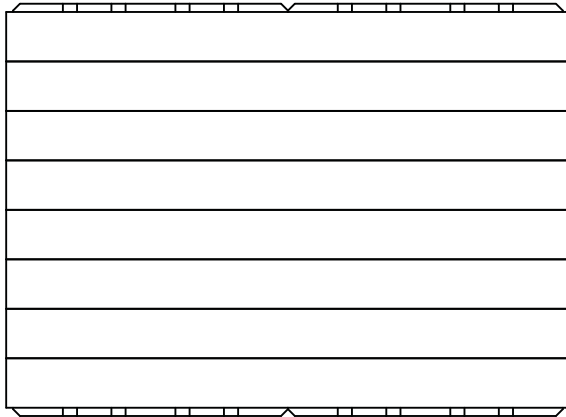
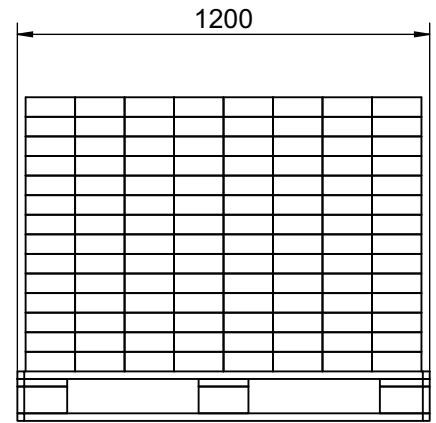
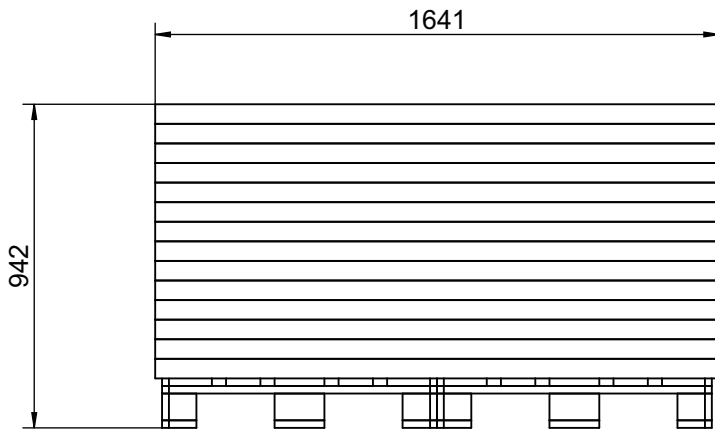

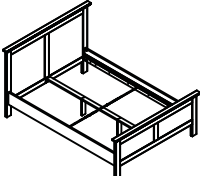
Rev.	Latest Revision / Description						
C	Palle TS40 089113 ændret til 2 stk. EUE-palle 089042y.						
Item number	Component	Pcs.	L	W	T	Gross weight in kg	Net weight in kg
089042y	Palle, EUR	2	1200	800	144		
Box 3 af 3		112	1641	144	57	7,8	7,4
 76701-77802	Seng Paris		INIT:	JR	DATE :	18-01-2010	
			REVISION:	C	Approved by:	JR	
DWG.NO.		76701-77802-70					